

August 23, 2015

### Millwork - Waterford - Southway

1. Main Dining Room
  - i) centre feature area between columns
  - ii) buffet area between columns
  - iii) built-in seating
  - iv) wood cladding at entrance
  - v) cantilevered wood ceiling
2. Coffee Bar
  - i) suspended ceiling (TBD)
  - ii) millwork similar to Barrie
  - iii) coffee bar table
3. Mail Room: Lower cabinetry & counter top
4. Tuck Shop: exterior wood paneling
5. Library/Internet: Internet stations (back-to-back); built-in seats
6. Main Street Lounge @ corridor (154): Wall units
7. Lounge (120): Aquarium
8. Bar Lounge (132/152)
9. Craft Kitchen (131)
10. Hair Salon (140)
11. Wellness Office (125/135): Dr Office & Med Room: cupboard/counter & sink
12. Memory Care Lounge (132): main Kitchen; TV area
13. Laundry (110) : Lower cupboards & counter top
14. Activity Lounge (109)
15. Corridor Side of Activity Lounge: millwork panels
16. Pool Washrooms: New Vanities
17. Fitness: cupboard & counter top

#### 2nd Floor

18. Nurse/Med Room (233): office work station; cupboard; counter & sink
19. Dr Office (236) cupboards/counter/sink
20. Dining Room (219): Linen Cabinet
21. Main Lounge (212): cabinetry & sink
22. Activity Room (212): TV wall unit
23. Apartment: kitchen & washroom

#### Suites

24. 1 & 2 Bedroom Suites: galley kitchen similar to Barrie
25. Studios (tower Only): small kitchenette with bar fridge (no sink)

# 211

# COFFEE BAR HILLWORK

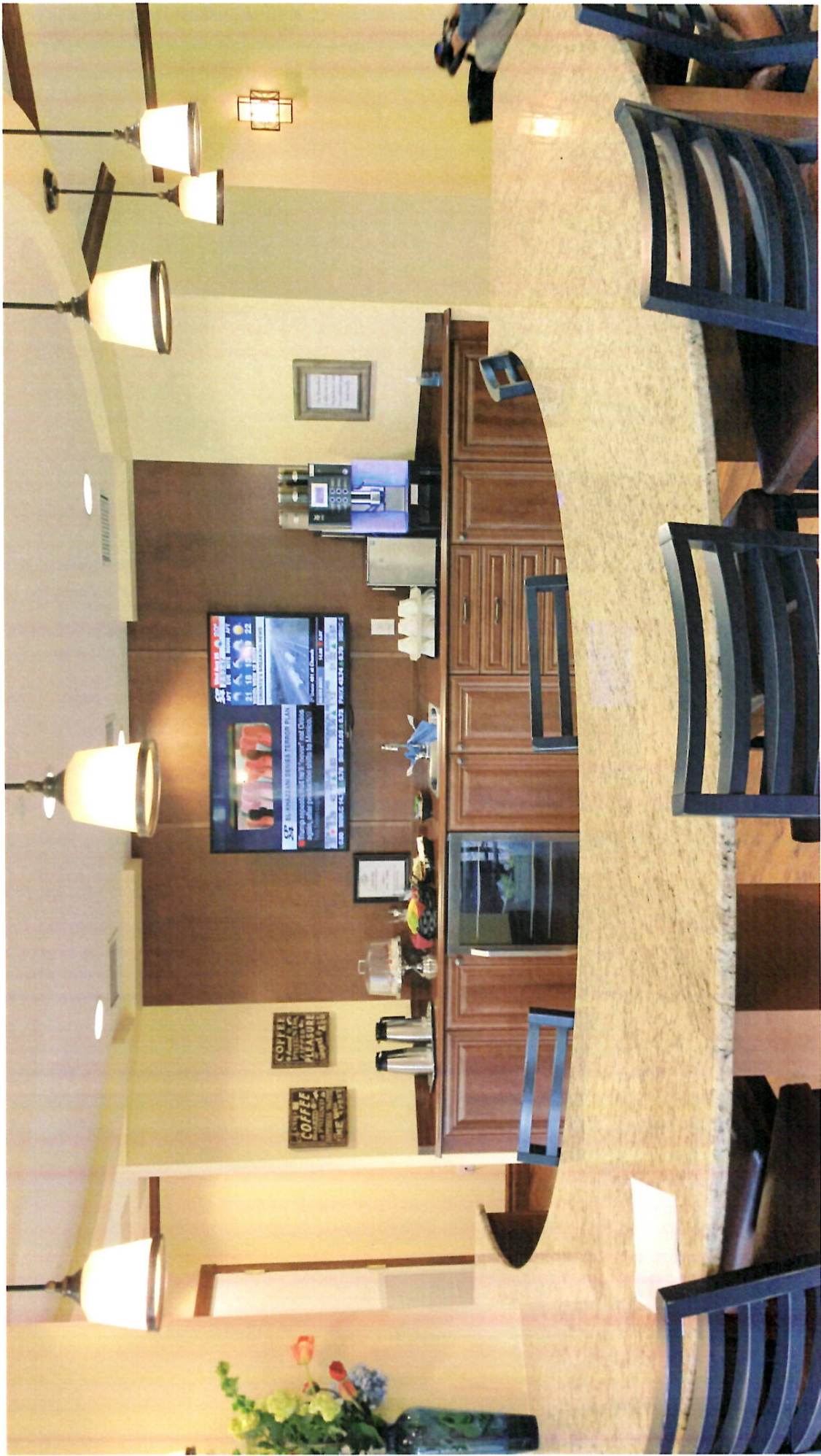

COFFEE BAR TABLE

#8111

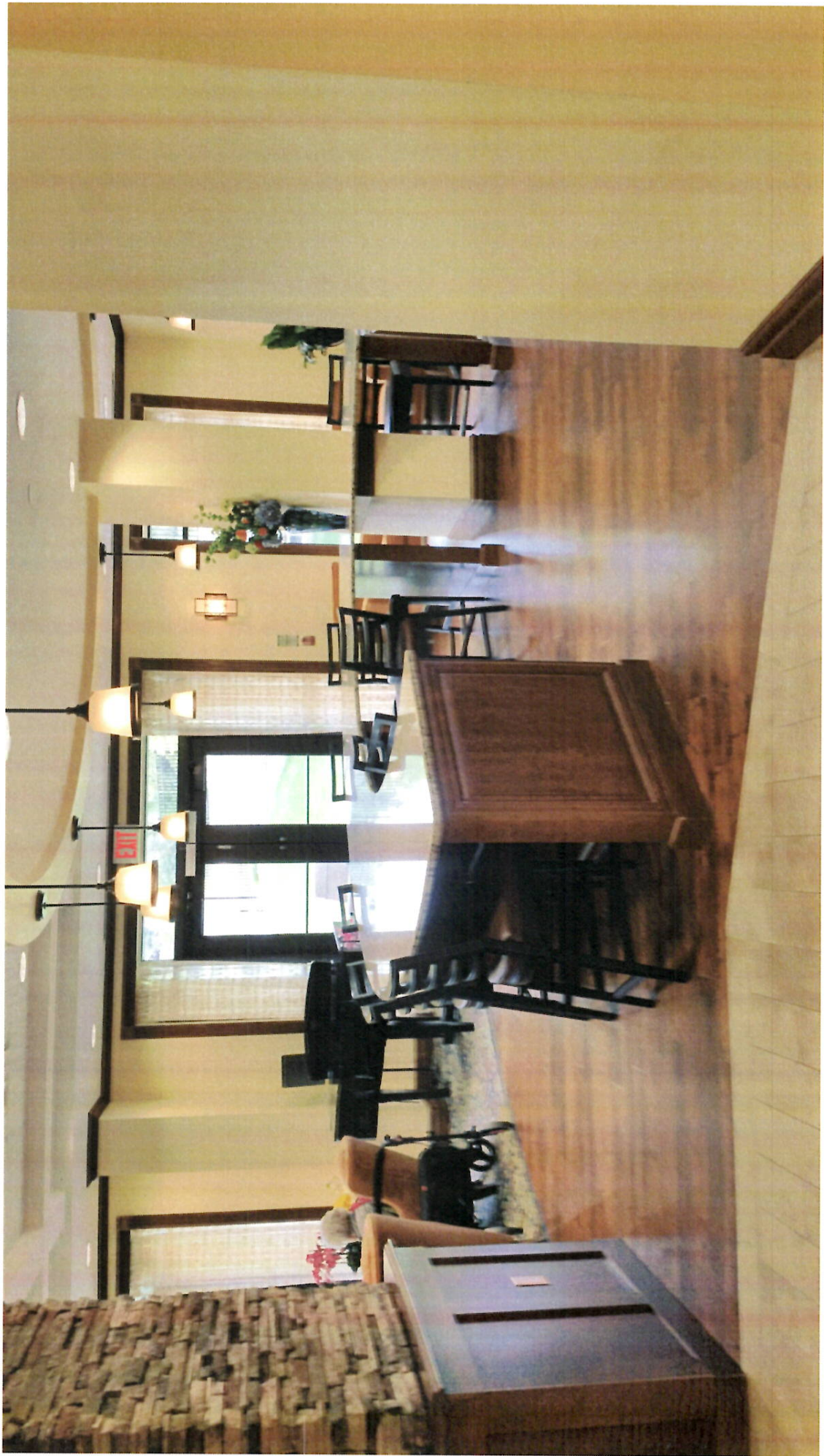

ORA Kitchens - Waterford Retirement - Phase 2 - Shop Drawings - LOUNGE - 151, COFFEE BAR - 152

# LOUNGE - 151, COFFEE BAR - 152

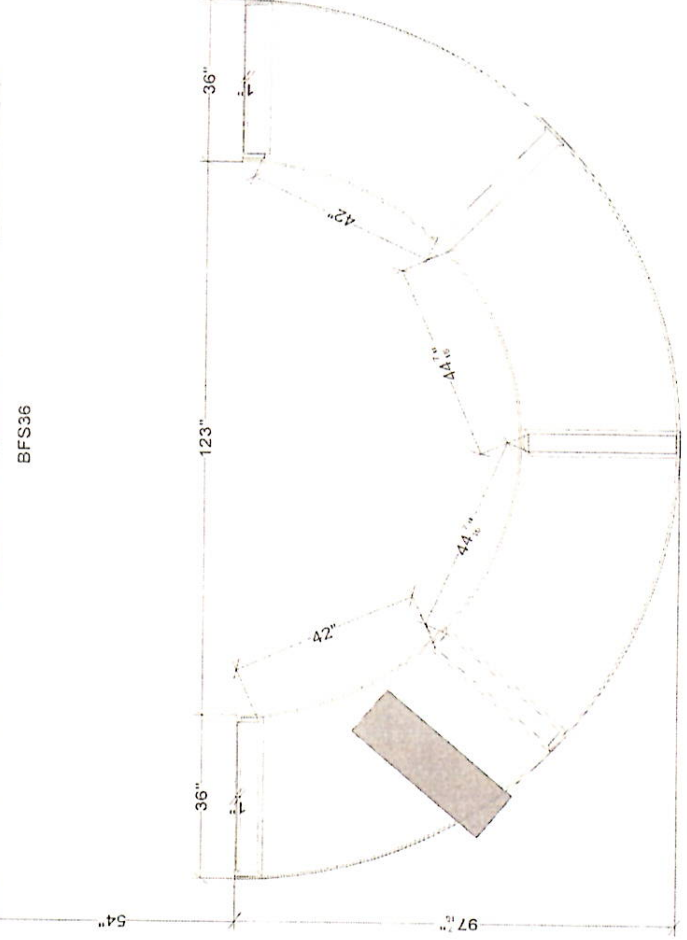
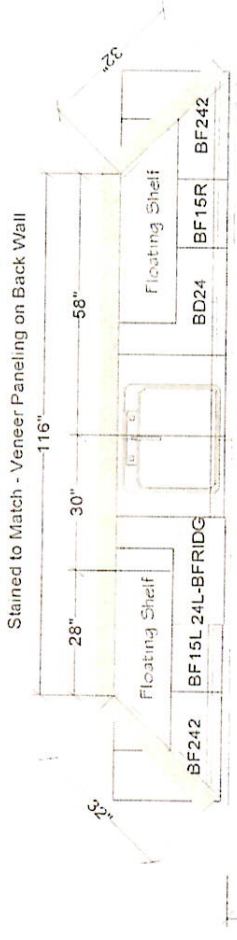

2ii/iii

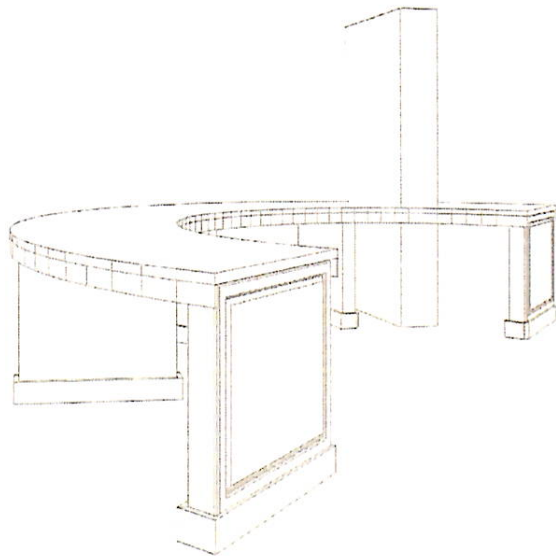
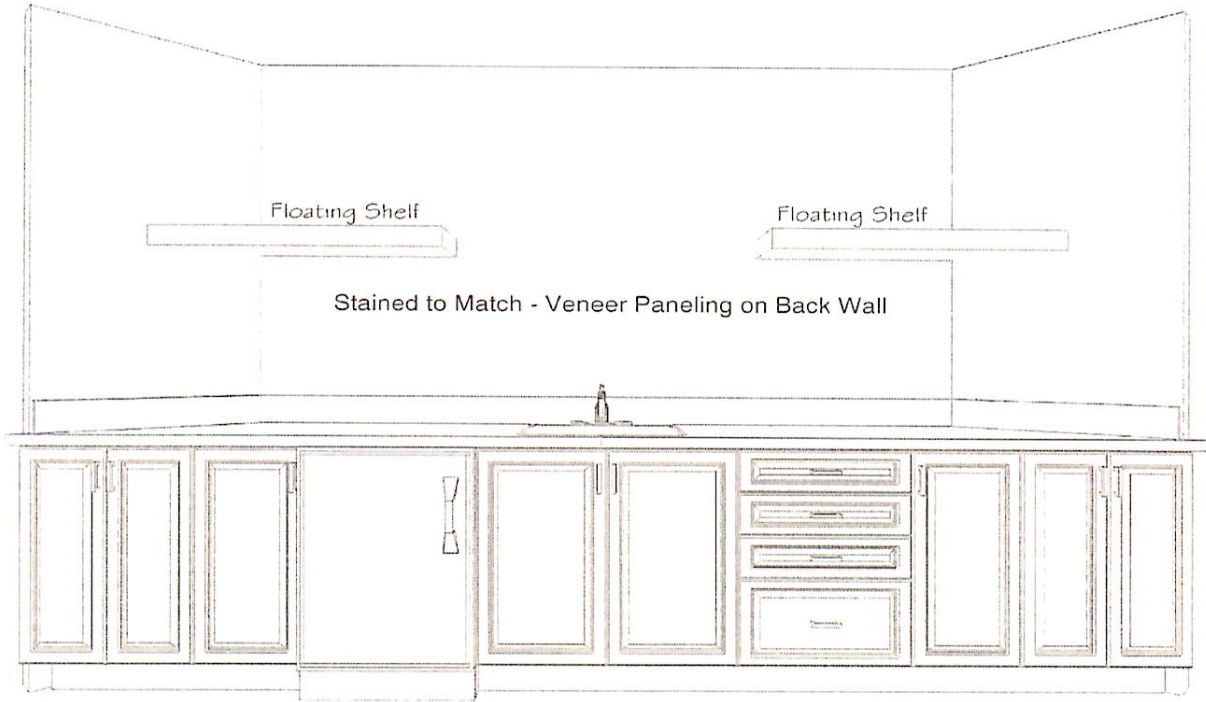

#3

# MAIL ROOM - 167

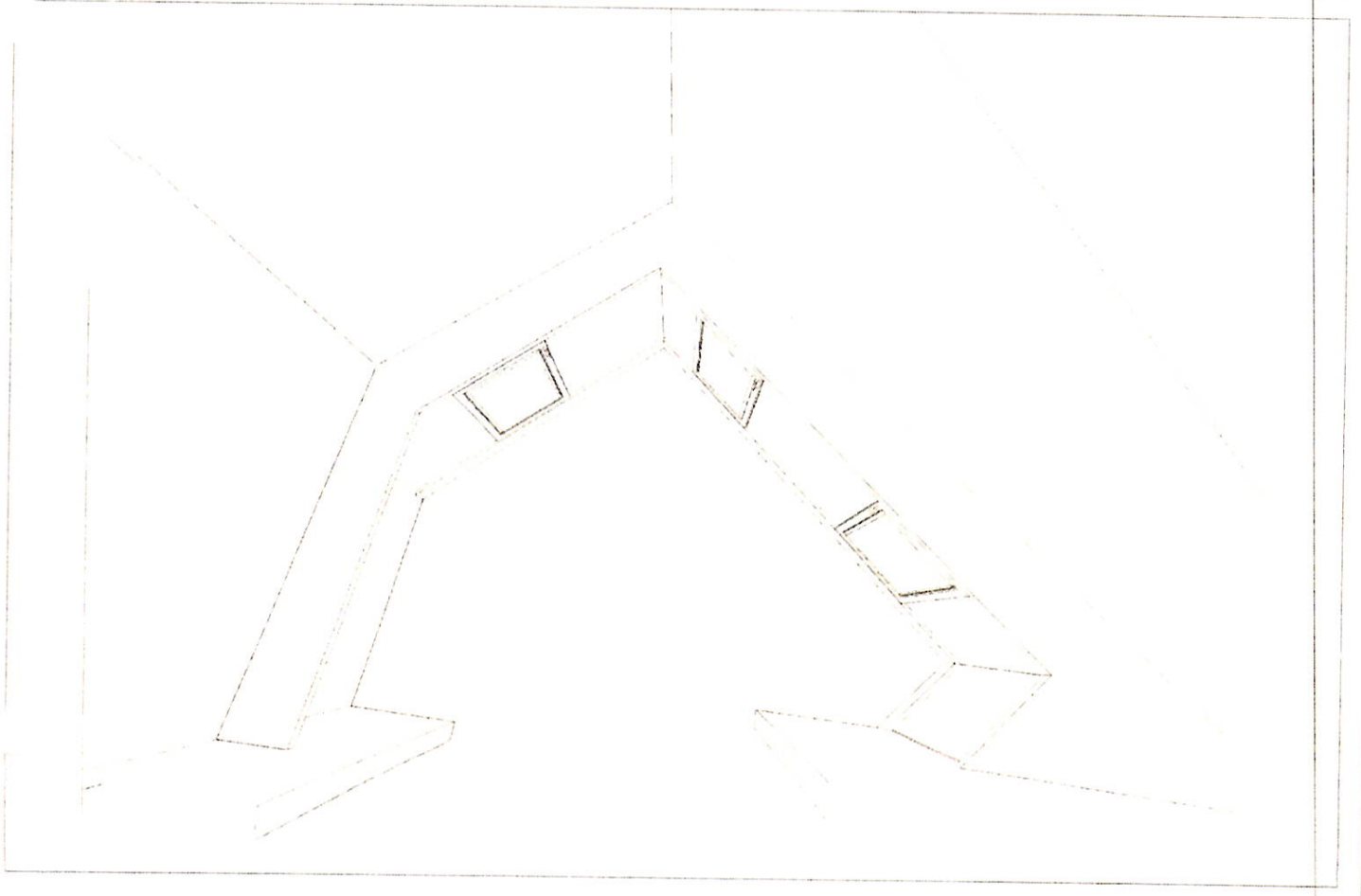
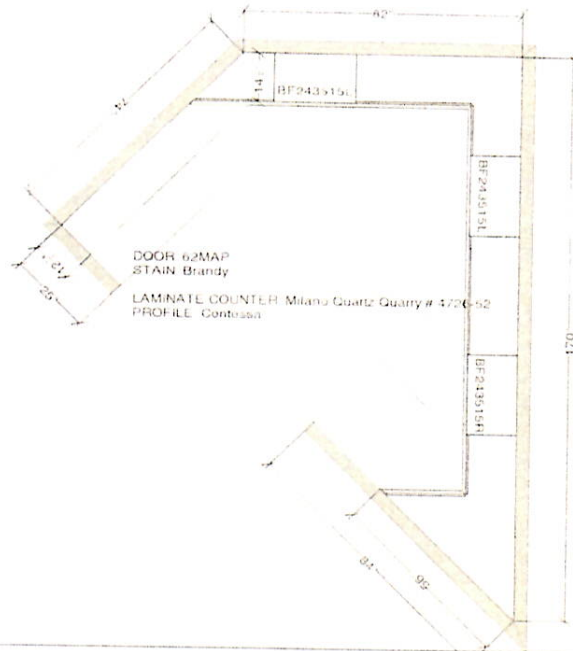

AQUARIUM

#



# LOUNGE - B70

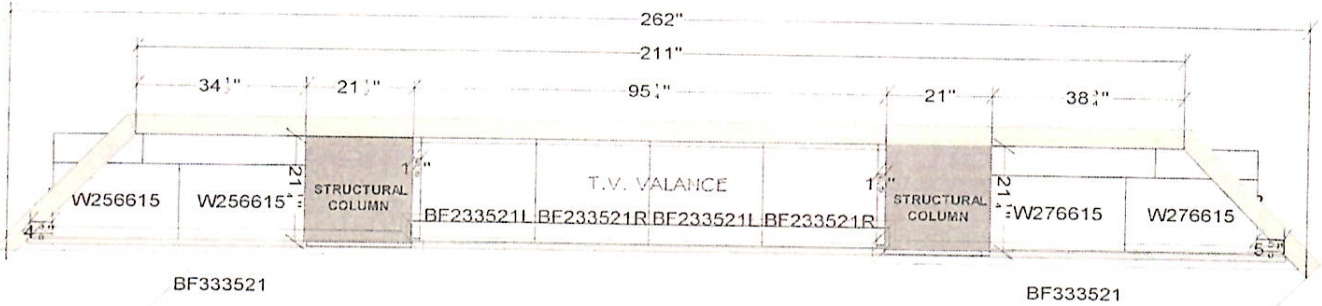

DOOR: 62MAP  
STAIN: BRANDY

COUNTER: Maple Wood to Match Cabinetry  
PROFILE: 1 1/4" - Wood Ogee

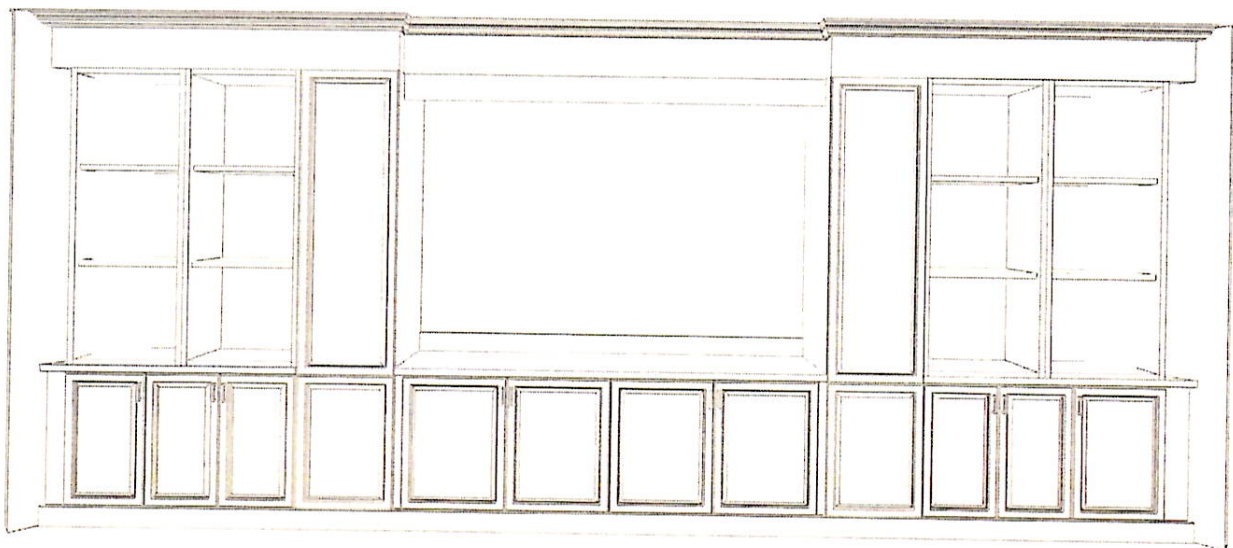

BAR LOUNGE

#8

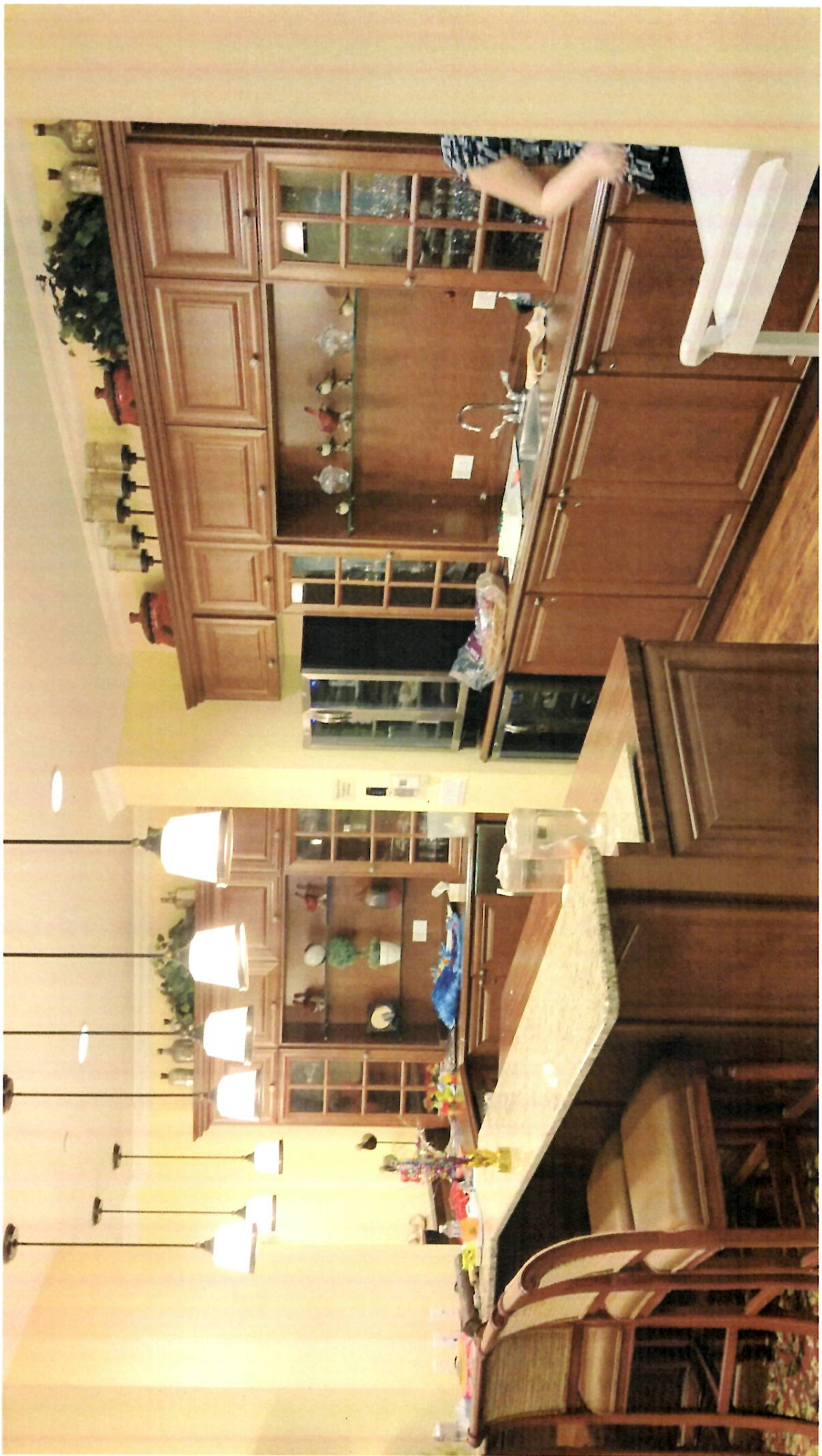



ORA Kitchens - Waterford Retirement - Phase 2 - BAR - B54 - Revised

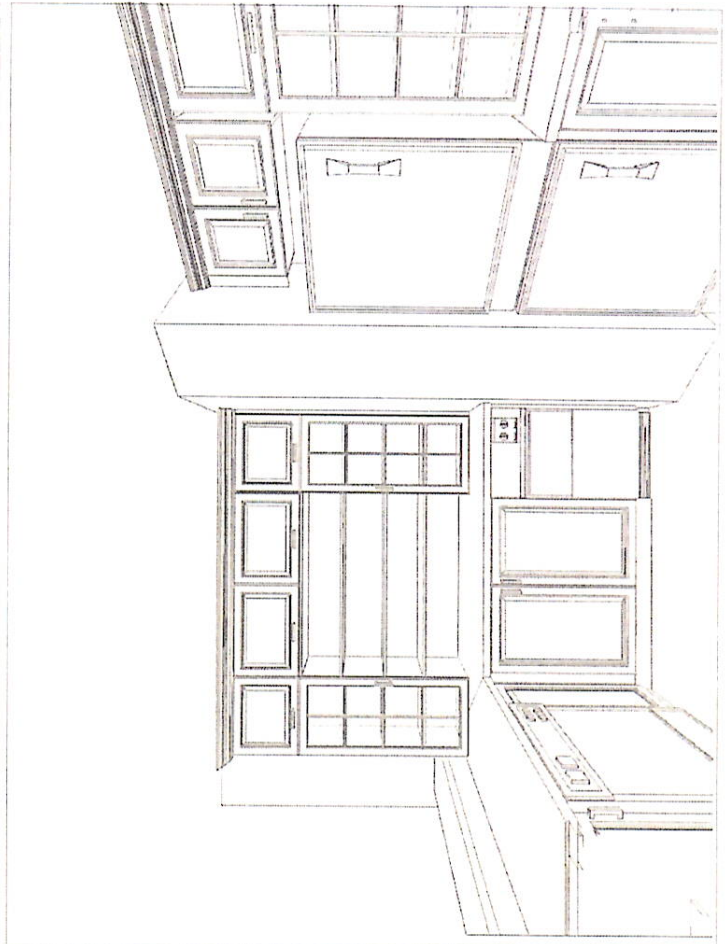
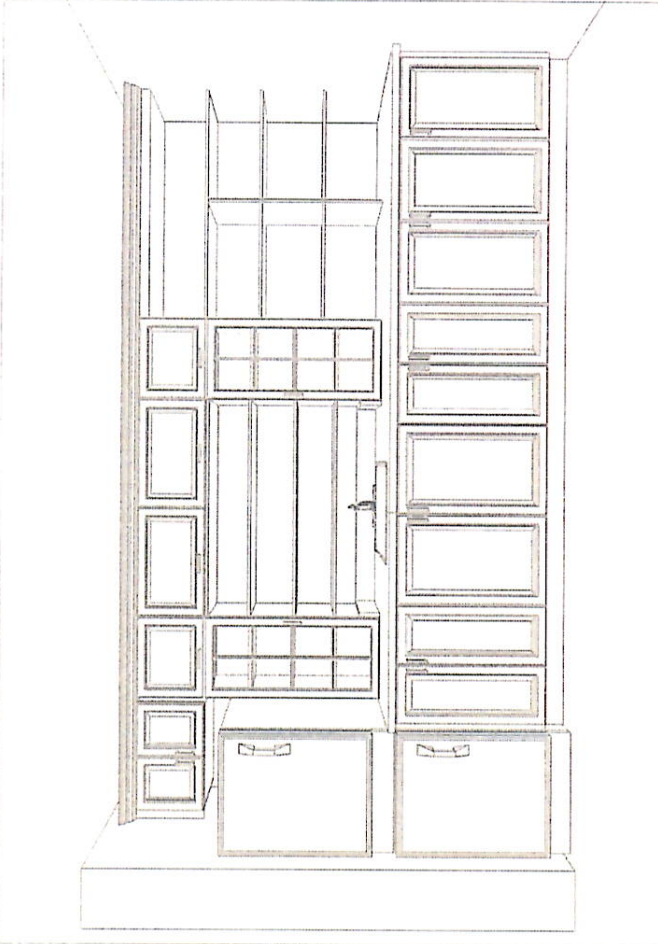
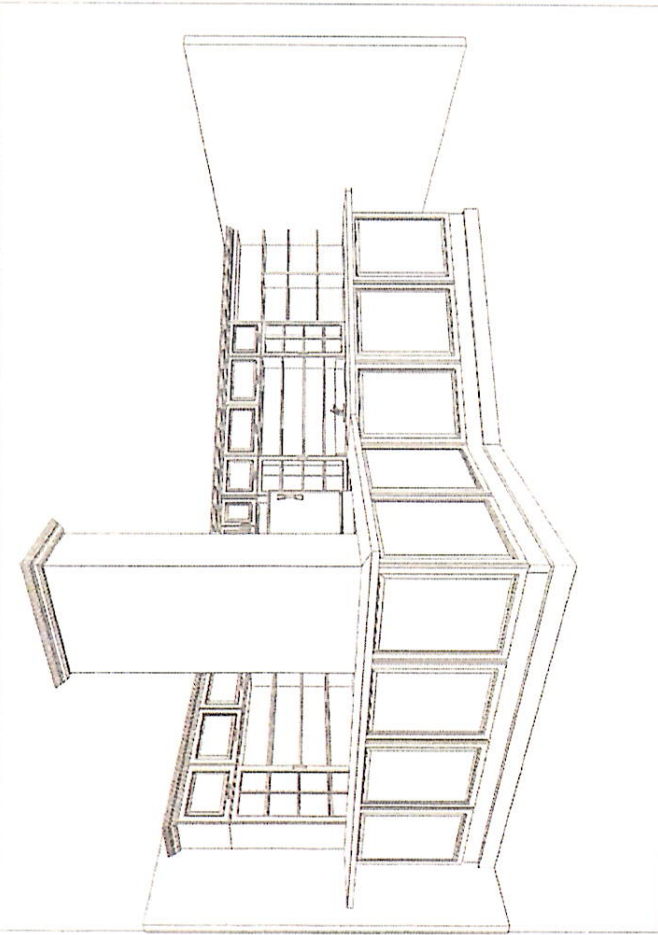

CRAFT DEMONSTRATION KITCHEN #9



5#

# CRAFT / ACTIVITY ROOM - KITCHEN - B66

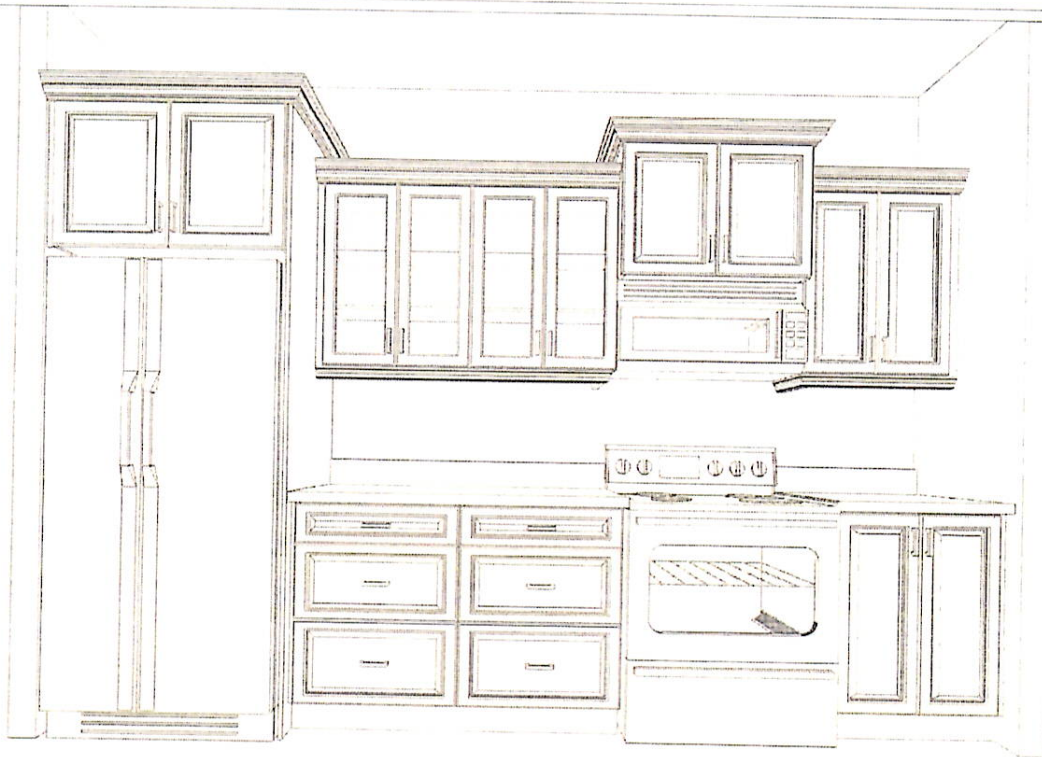
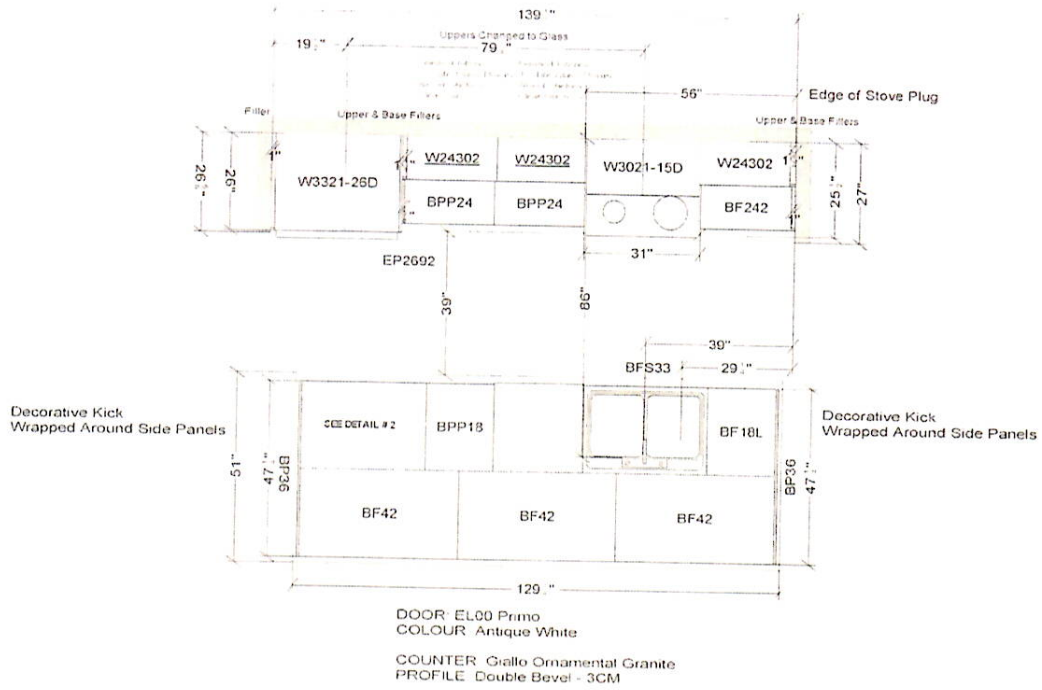

CRAFT / ACTIVITY ROOM - KITCHEN & ISLAND - B66 - Revised

5  
#

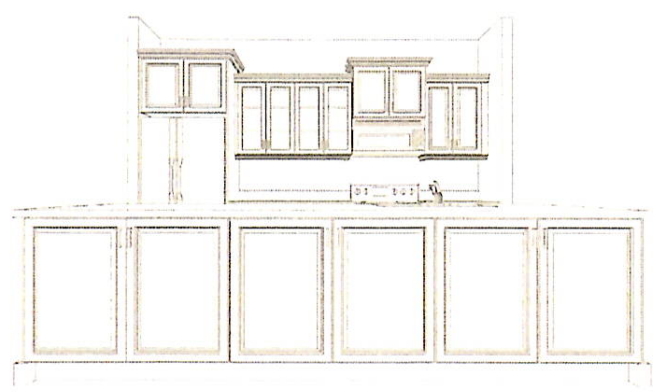
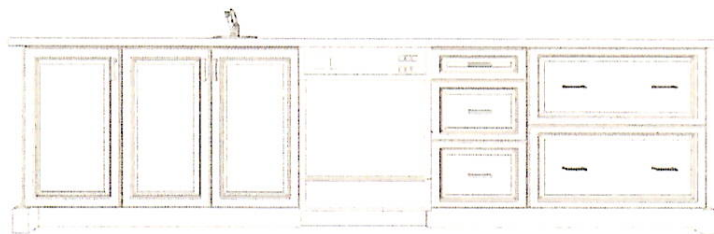
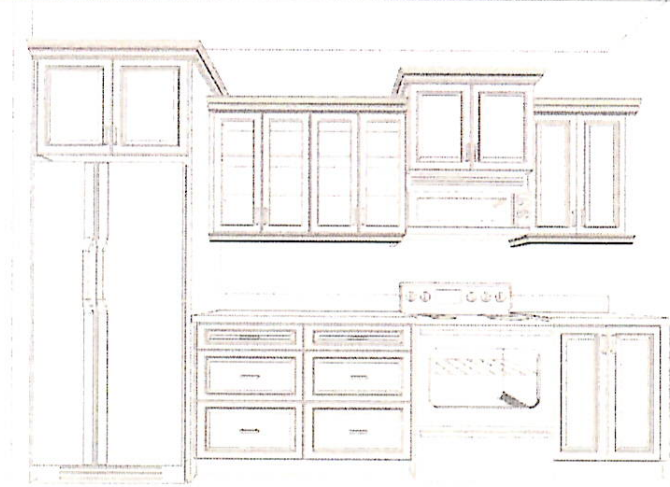

#10

HAIR SALON



#

# HAIR SALON - B58

## COFFEE BAR

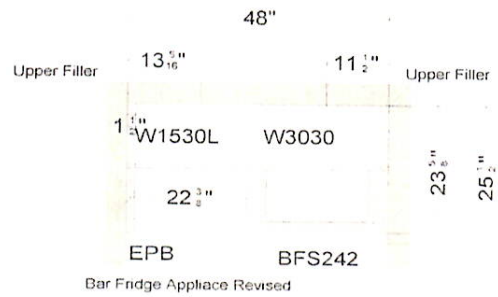

DOOR: 62MAP  
STAIN: BRANDY

COFFEE BAR COUNTER: Giallo Ornamental Granite  
PROFILE: Double Bevel - 3CM

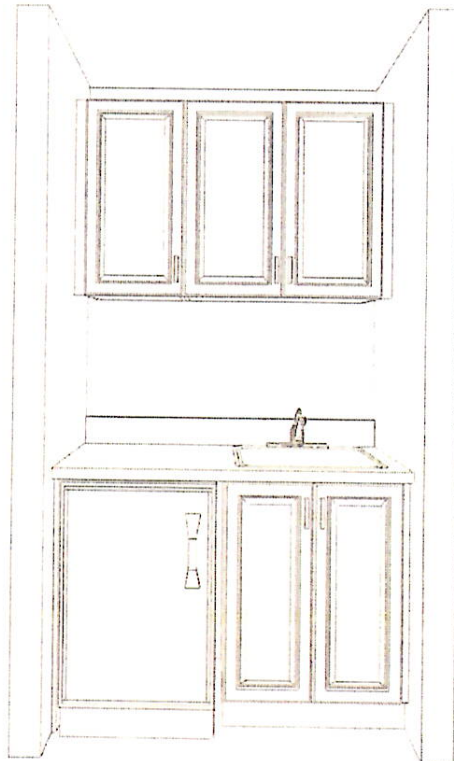

0  
#

# HAIR SALON - B58

## WASHING STATION

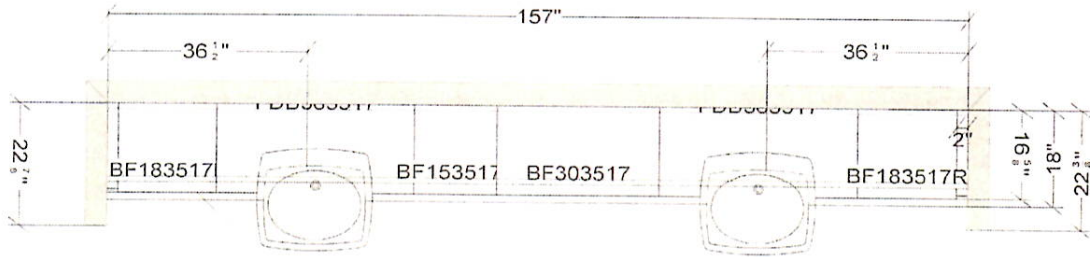

DOOR: 62MAP  
STAIN: BRANDY

WASHING STATION COUNTER: Milano Quartz Quarry # 4726-52  
PROFILE: Contessa

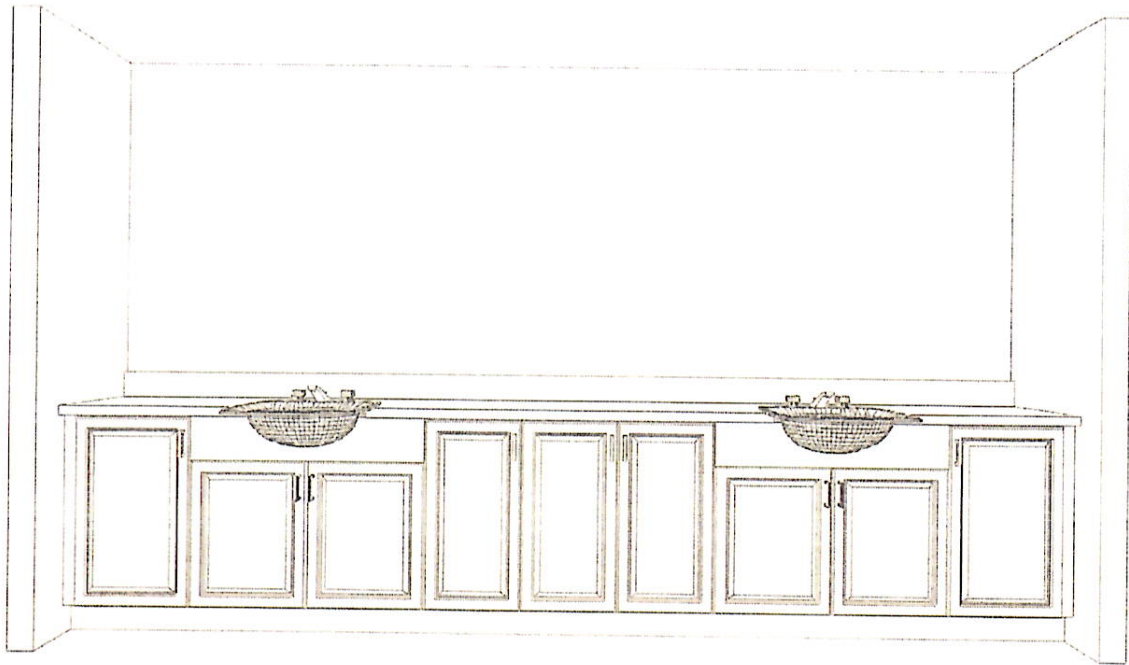

# HAIR SALON - B58

## STYLING STATION

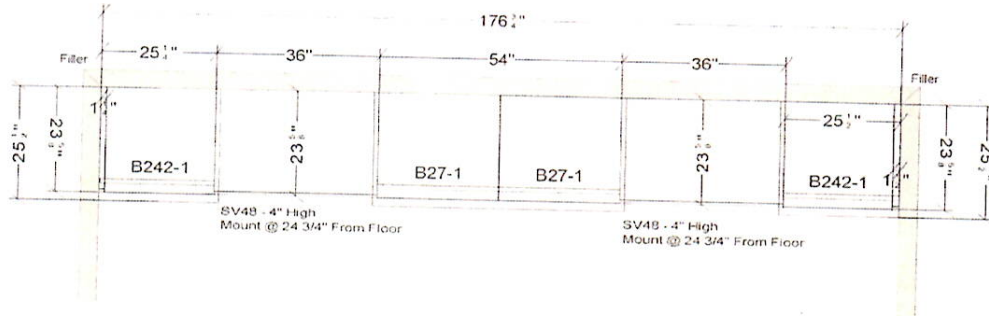

DOOR: 62MAP  
STAIN: BRANDY

STYLING STATION COUNTER: Milano Quartz Quarry # 4726-52  
PROFILE: Contessa

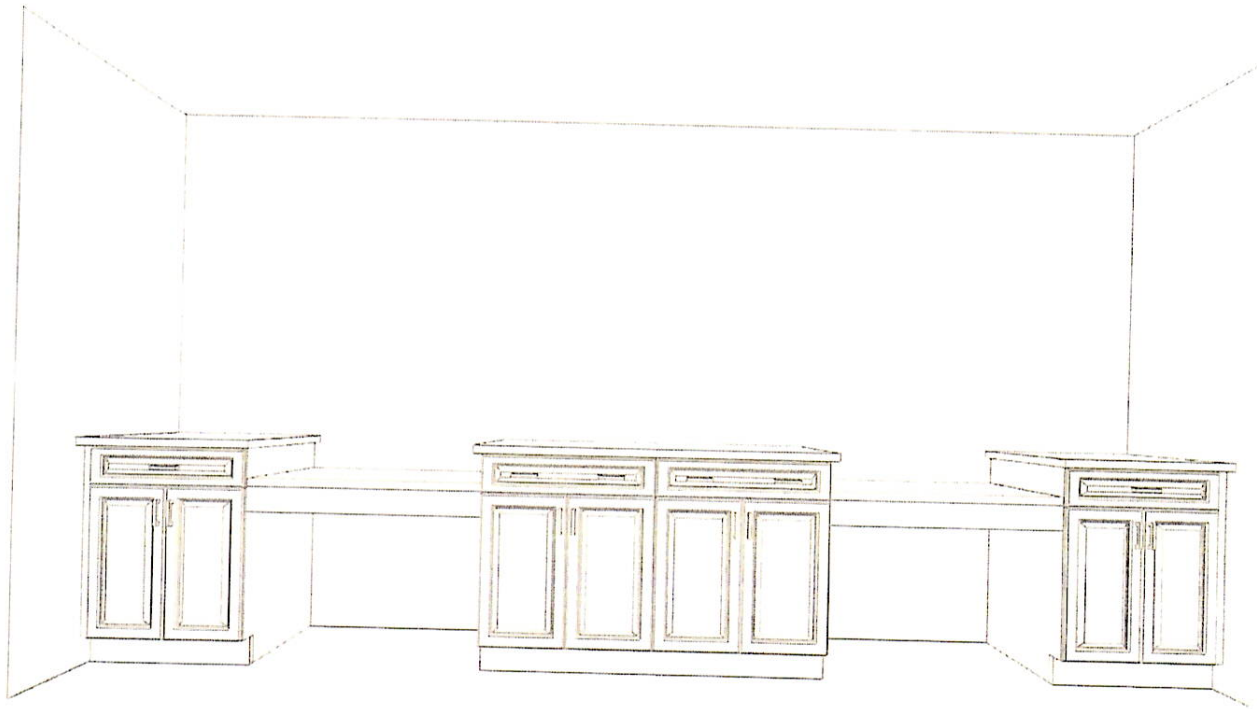

ORA Kitchens - Waterford Retirement - Phase 2 - Shop Drawings - HAIR SALON - B58

**STYLING / CUTTING STATION - ELEVATION**

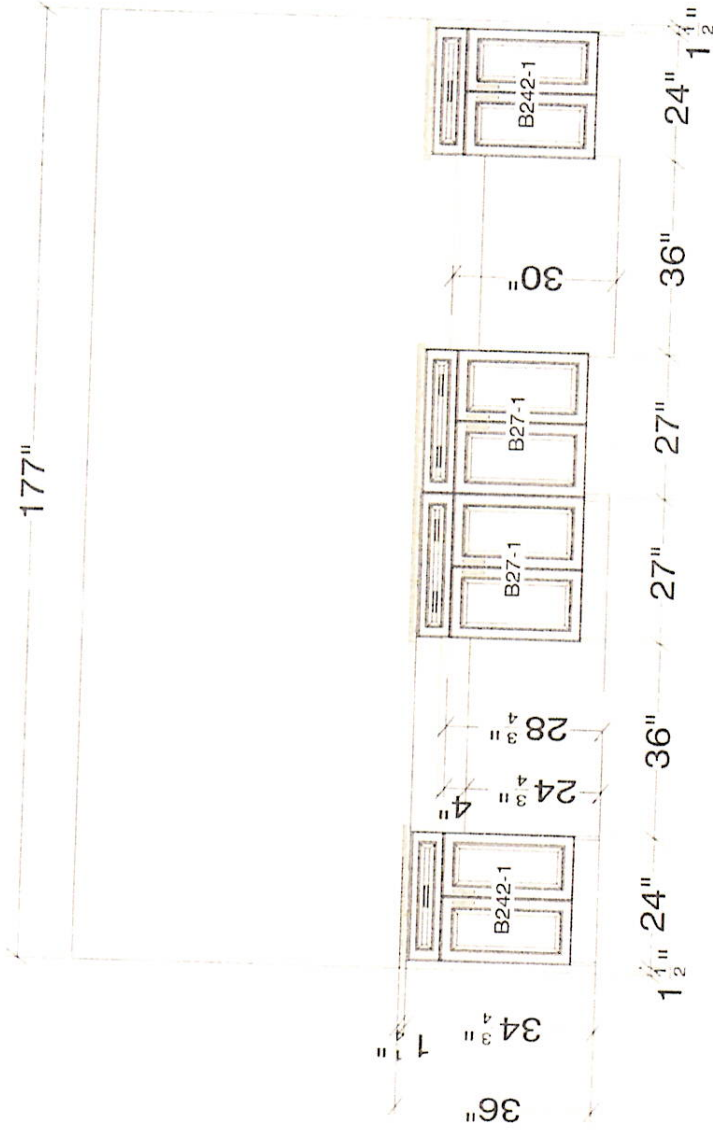

# 11, 18, 19

ORA Kitchens - Waterford Retirement - Phase 2 - Shop Drawings  
WELLNESS ACTIVITY ROOM - 266

# WELLNESS ACTIVITY ROOM - 266

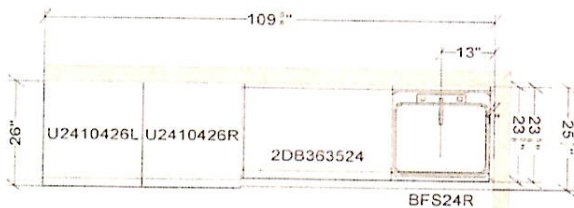

DOOR: EL00, Primo  
COLOUR: Antique White

Wall Location to be on Right side, not Left like Previous Drawing

COUNTER: Milano Quartz Quarry # 4726-52  
PROFILE: Contessa

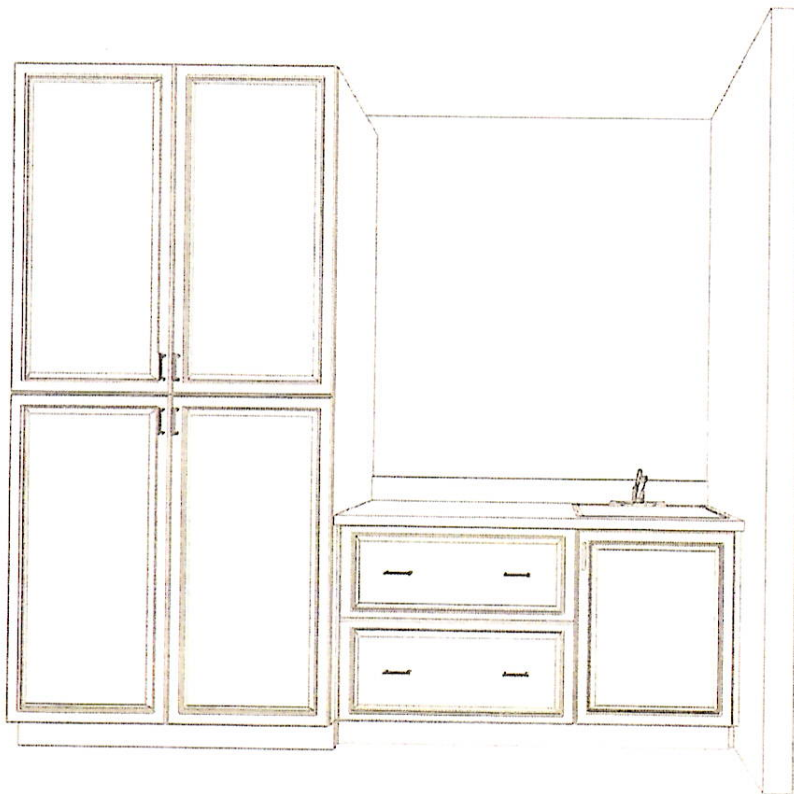

MEMORY CARE KITCHEN

#12



01#

# ORA Kitchens - Waterford Retirement - Phase 2 - Shop Drawings DEMENTIA COMMON ROOM - KITCHEN - 178

## DEMENTIA COMMON ROOM - KITCHEN - 178

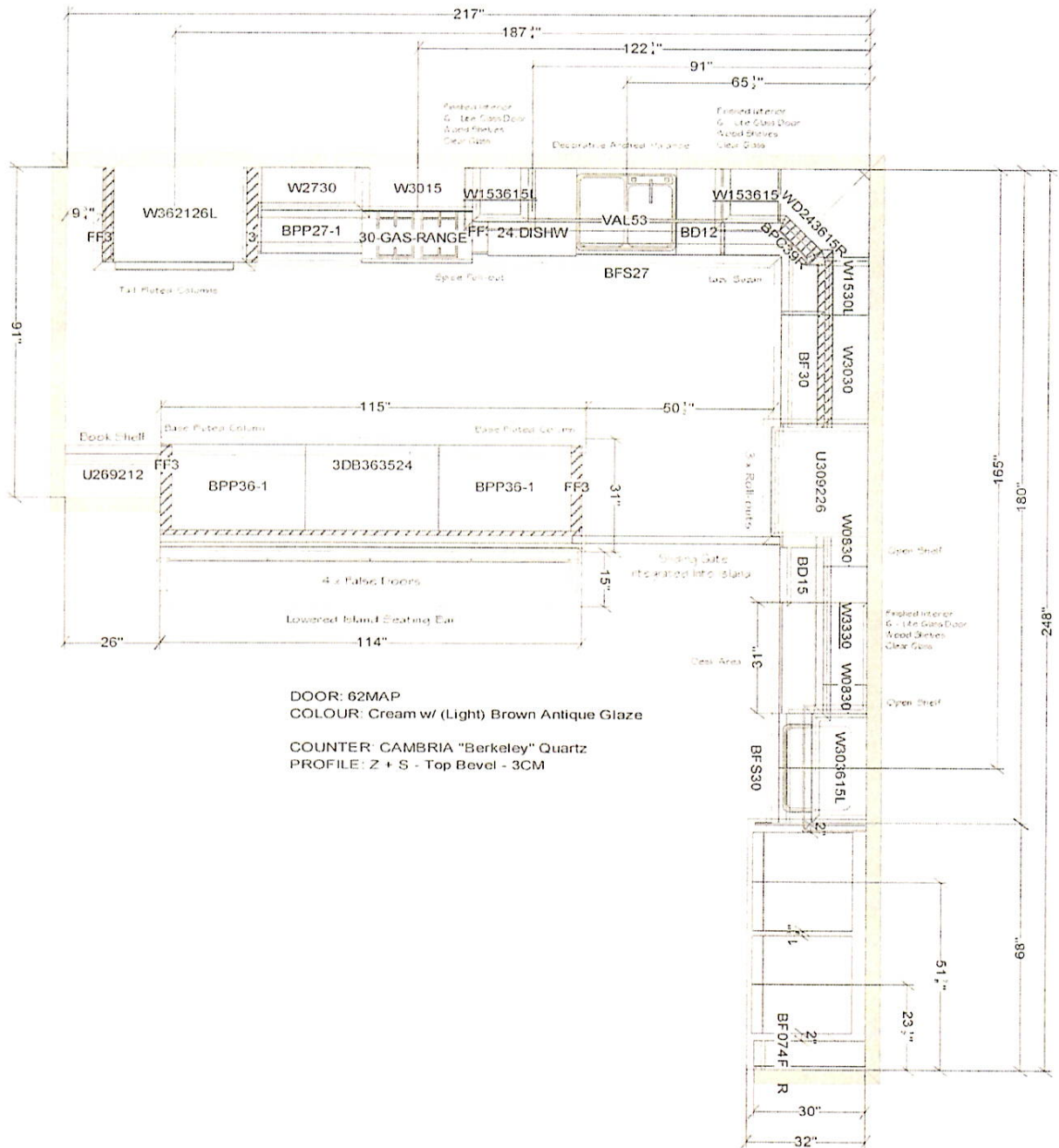

ORA Kitchens - Waterford Retirement - Phase 2 - Shop Drawings  
DEMENTIA COMMON ROOM - KITCHEN - 178

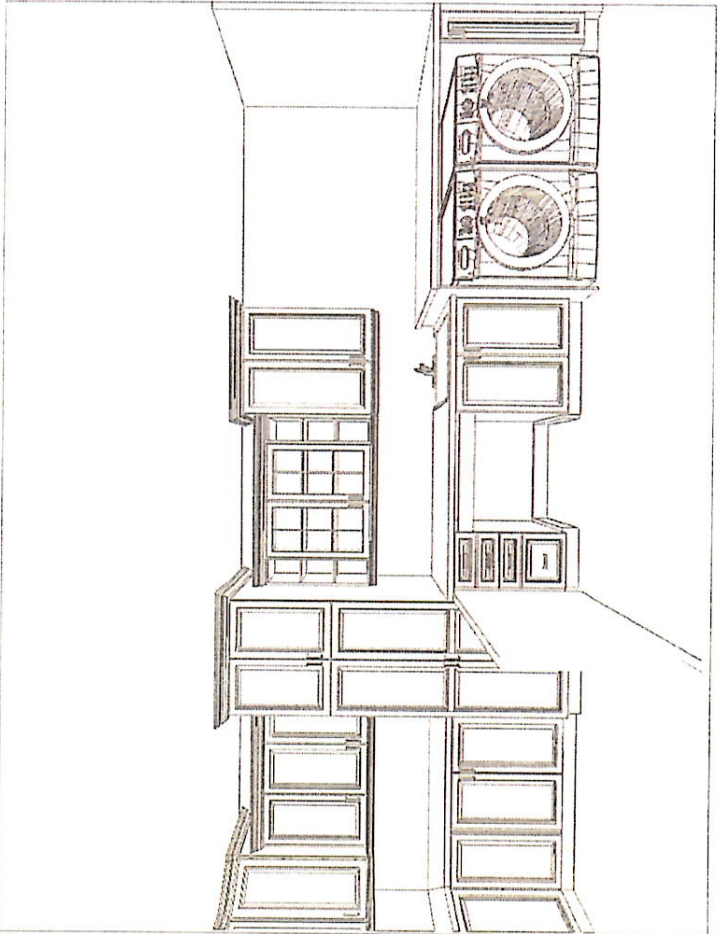
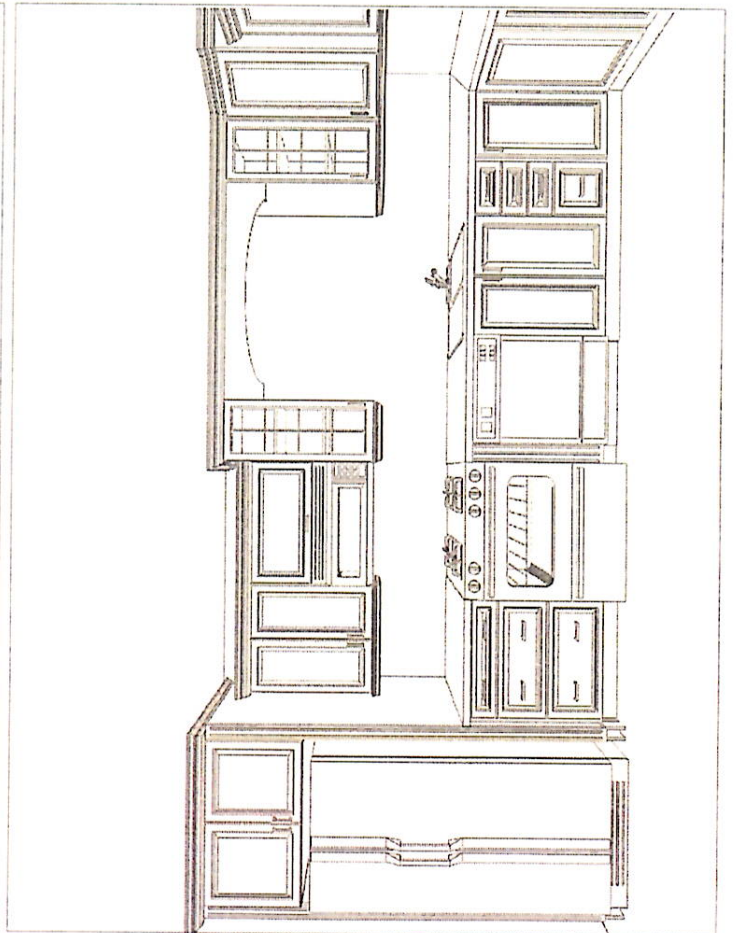
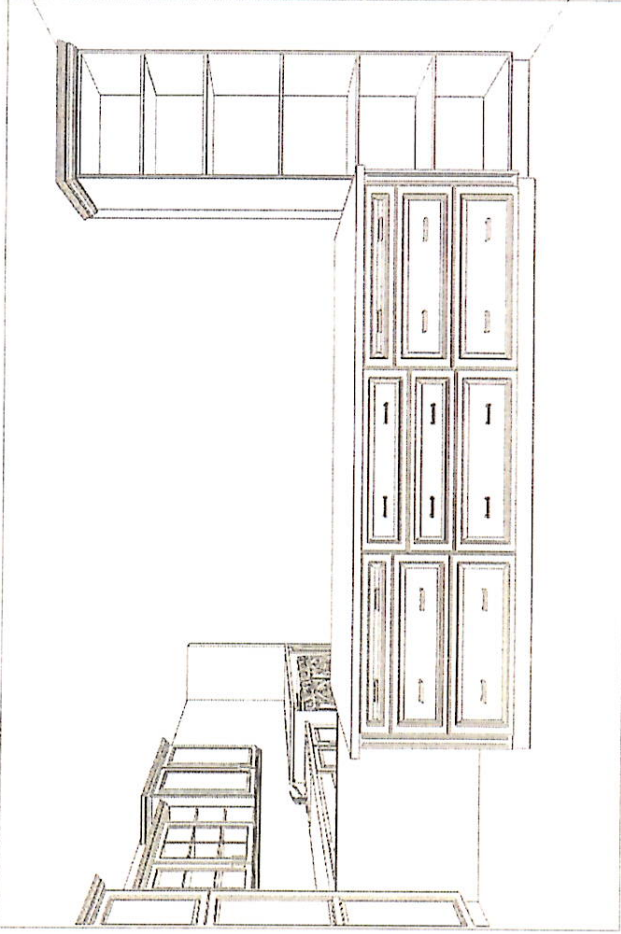
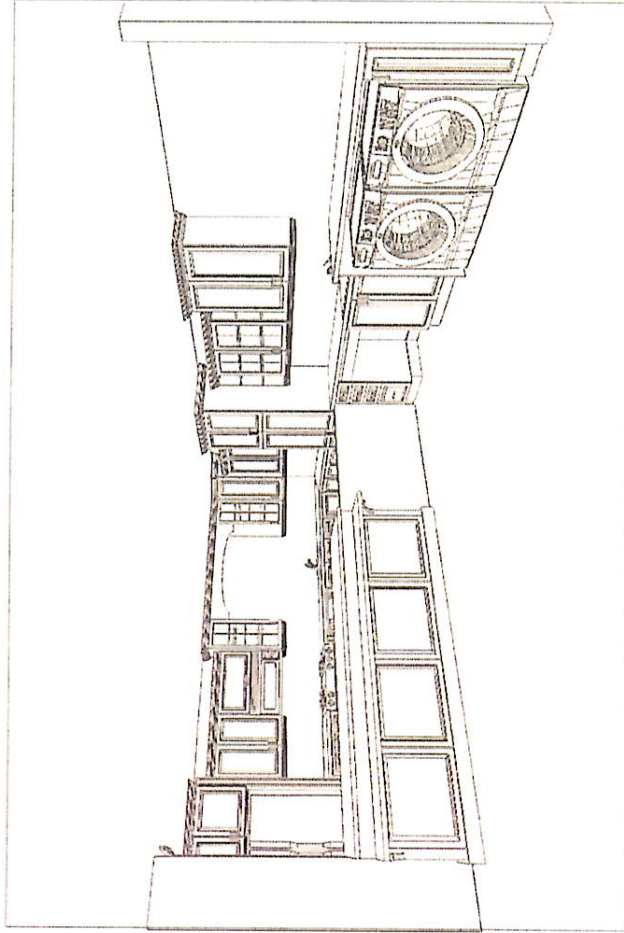

TV WALL UNIT

#12, 22.



20.01#

ORA Kitchens - Waterford Retirement - Phase 2 - Shop Drawings  
DEMENTIA COMMON ROOM - T.V. UNIT - 178

# DEMENTIA COMMON ROOM - T.V. UNIT - 178

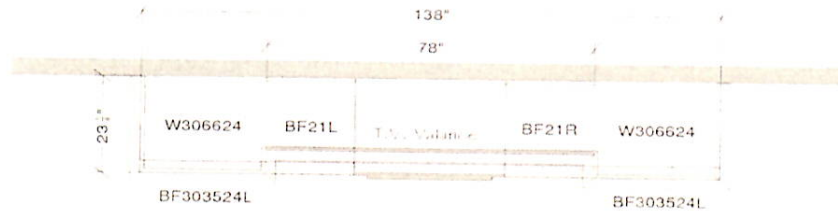

DOOR: 62MAP  
STAIN: BRANDY  
COUNTER: Maple Wood Counter Top  
PROFILE: 1 1/4" - Ogee

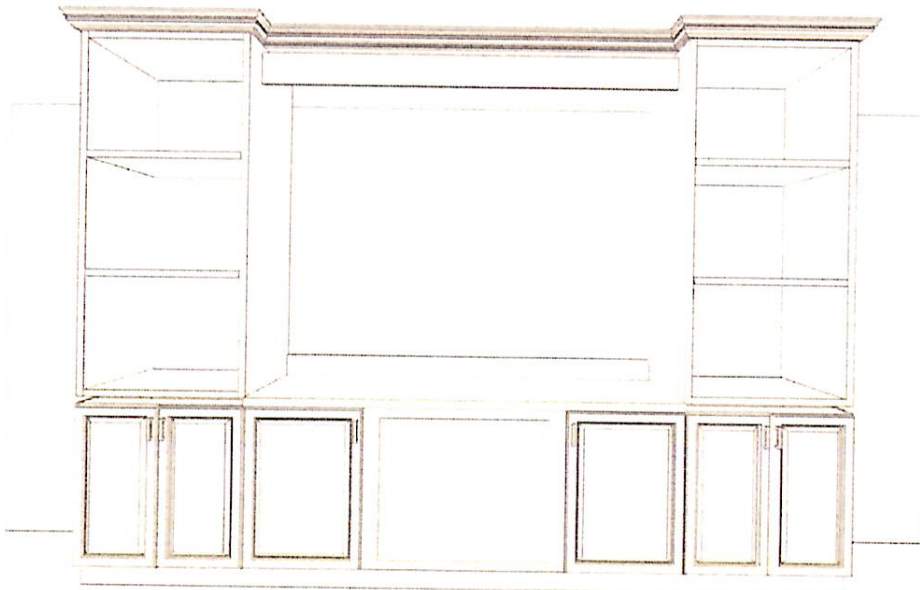

#13

# LAUNDRY ROOM - 258

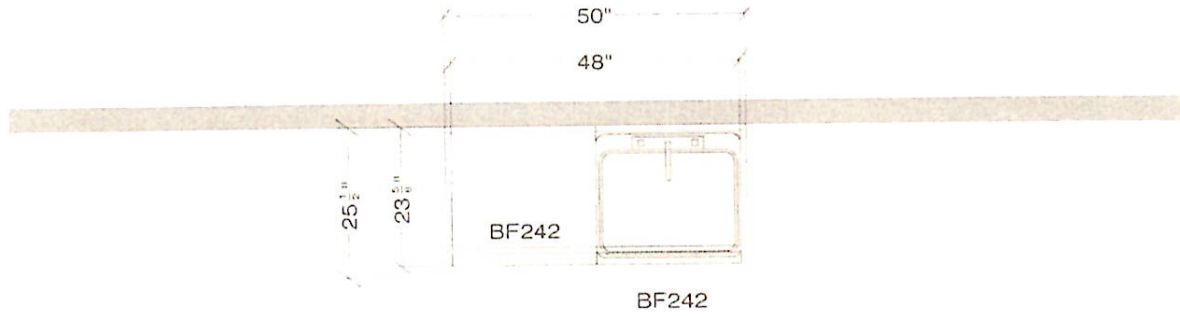

DOOR: B07, Bellini  
COLOUR: Antique White

LAMINATE COUNTER: Milano Quartz Quarry # 4726-52  
PROFILE: Contessa

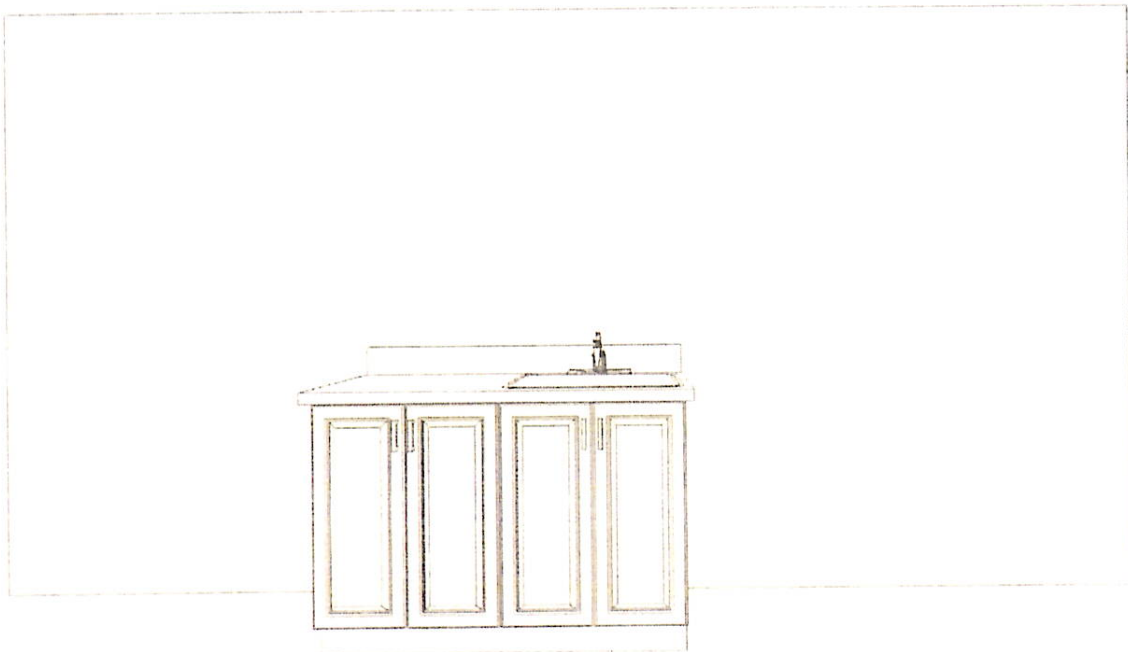

#13

OKA Kitchens - Waterford Retirement - Phase 2 - Shop Drawings

LAUNDRY ROOMS - 353, 453, 553

# LAUNDRY ROOMS - 353, ~~453~~, ~~553~~

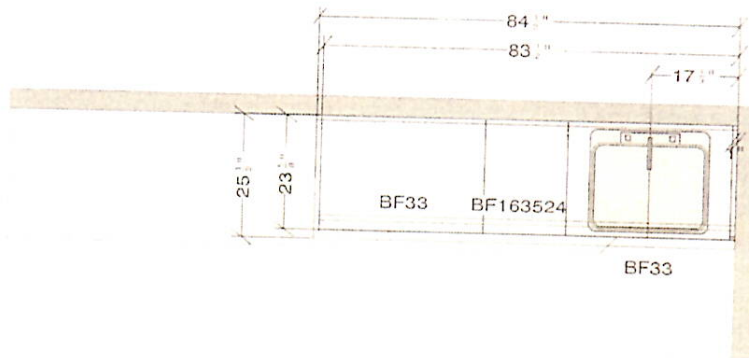

DOOR: B07, Bellini  
COLOUR: Antique White

LAMINATE COUNTER: Milano Quartz Quarry # 4726-52  
PROFILE: Contessa

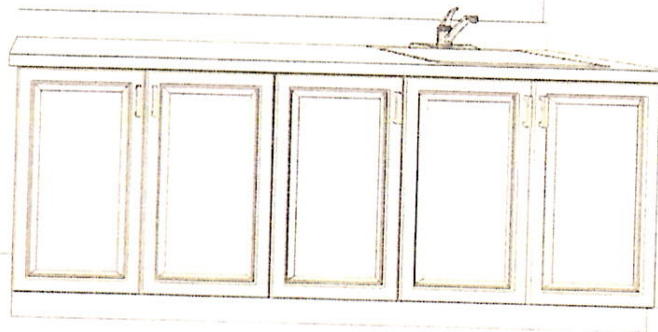

#13

ORA Kitchens - Waterford Retirement - Phase 2 - Shop Drawings

LAUNDRY ROOMS - 353, 453, 553

# LAUNDRY ROOMS - ~~353~~, 453, ~~553~~

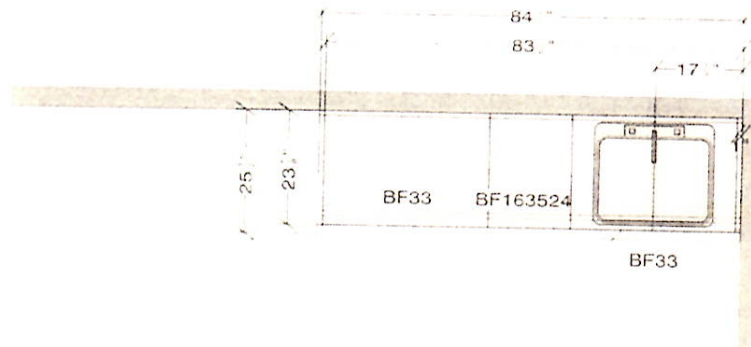

DOOR: B07, Bellini  
COLOUR: Antique White

LAMINATE COUNTER: Milano Quartz Quarry # 4726-52  
PROFILE: Contessa

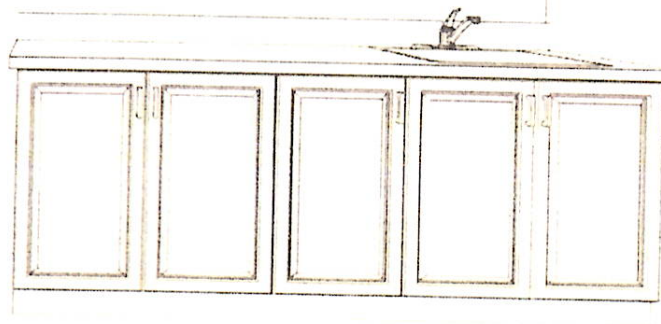

#13

# LAUNDRY ROOMS - ~~353, 453, 553~~

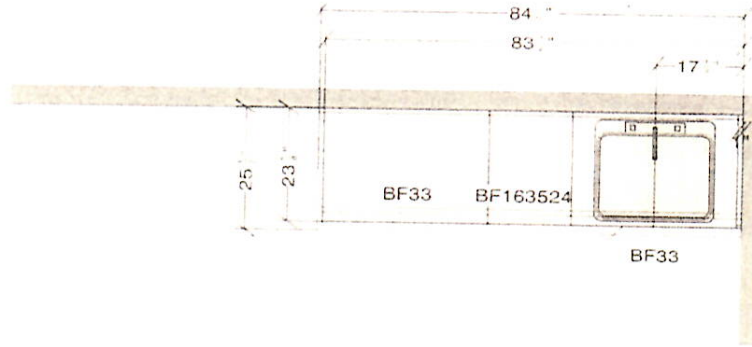

DOOR: B07, Bellini  
COLOUR: Antique White

LAMINATE COUNTER: Milano Quartz Quarry # 4726-52  
PROFILE: Contessa

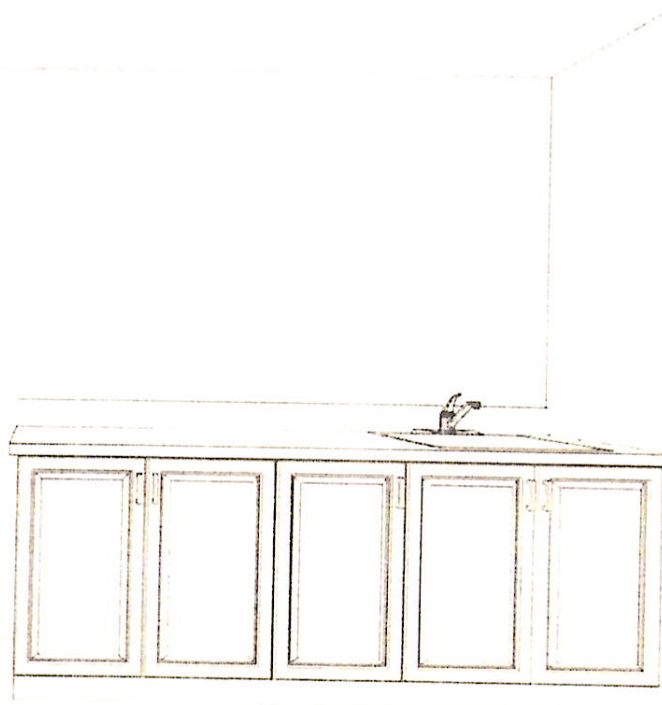

#14

CRAFT ROOM - ACTIVITY LOUNGE

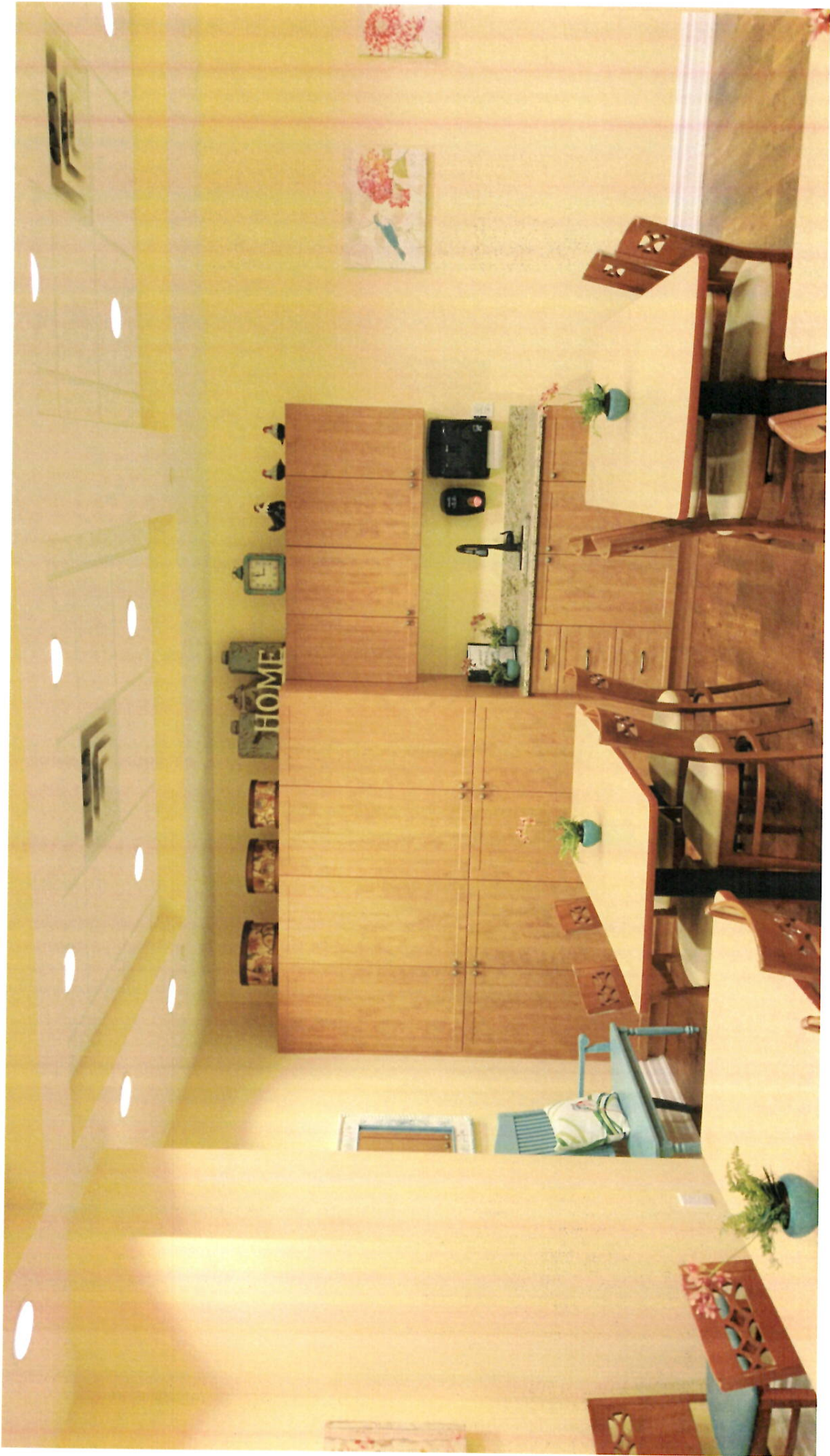

丁  
#

# CRAFT / ACTIVITY ROOM - CRAFT AREA - B66

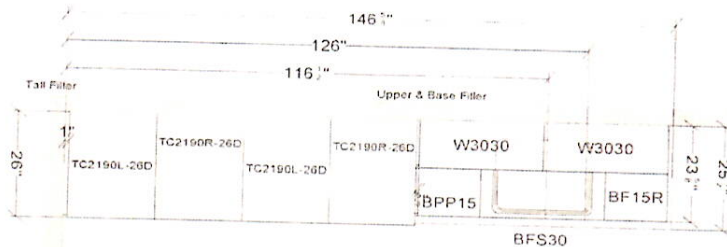

DOOR: B07 Bellini  
COLOUR: Wild Apple  
COUNTER: Gallo Ornamental Granite  
PROFILE: Double Bevel - 3CM

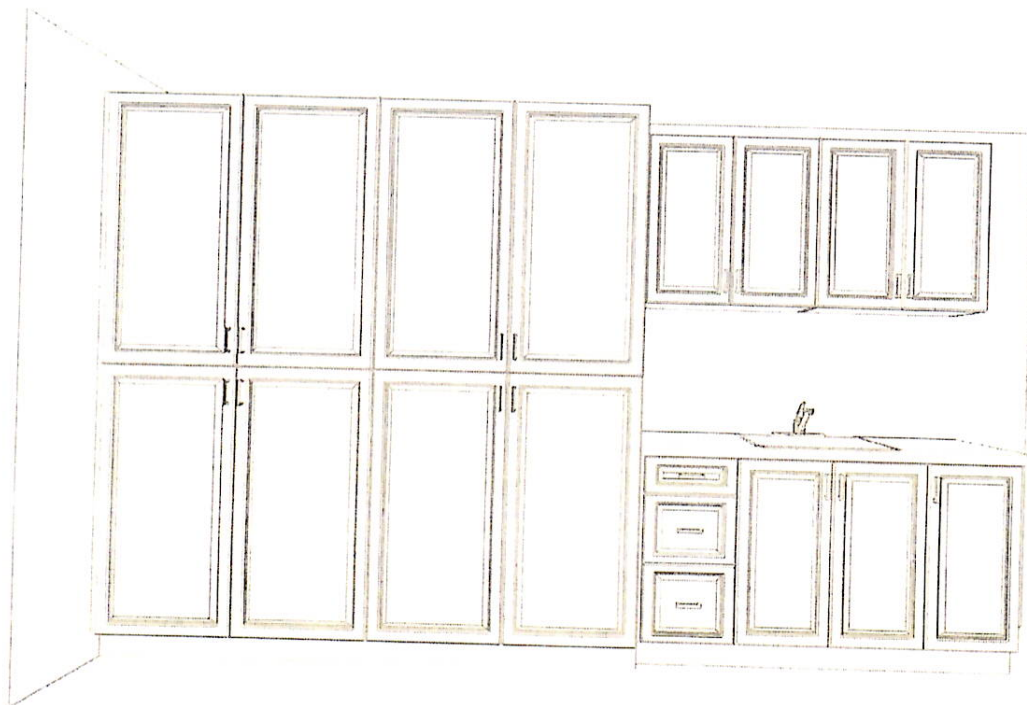

#119

ORA Kitchens - Waterford Retirement - Phase 2 - Shop Drawings  
PUBLIC WASHROOMS

Womens Washroom - B67

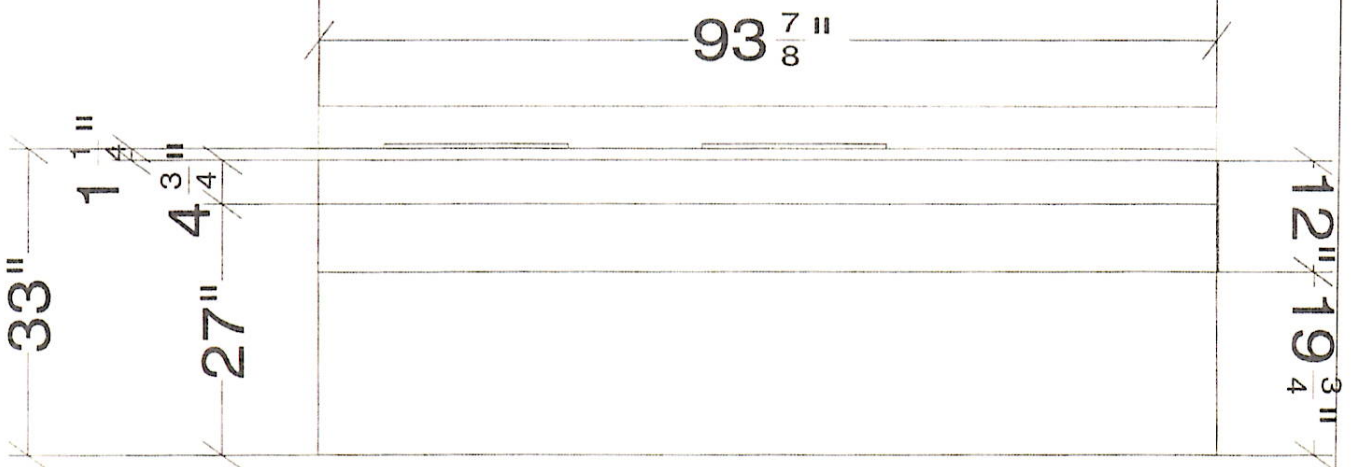
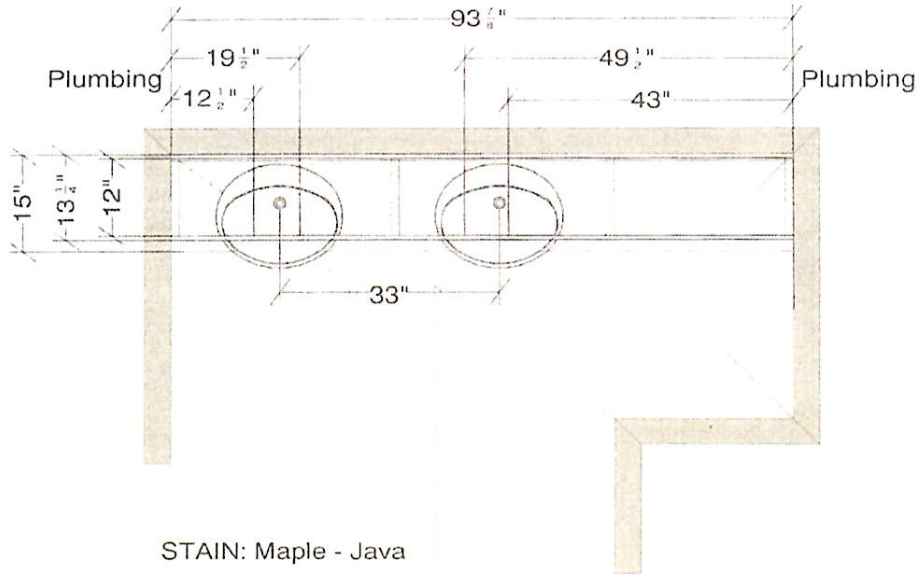

#16

Mens Washroom - B68

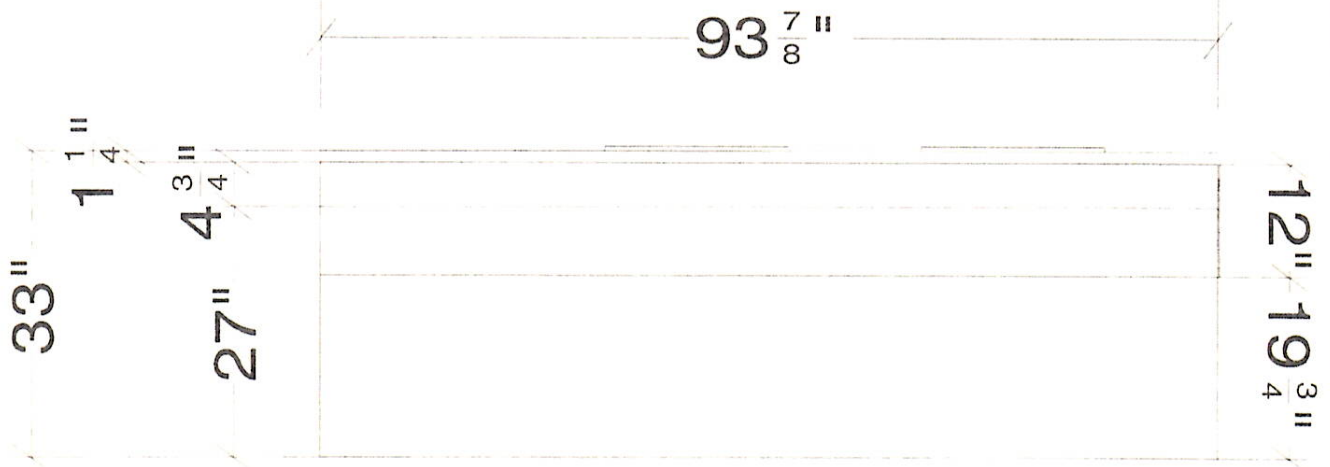
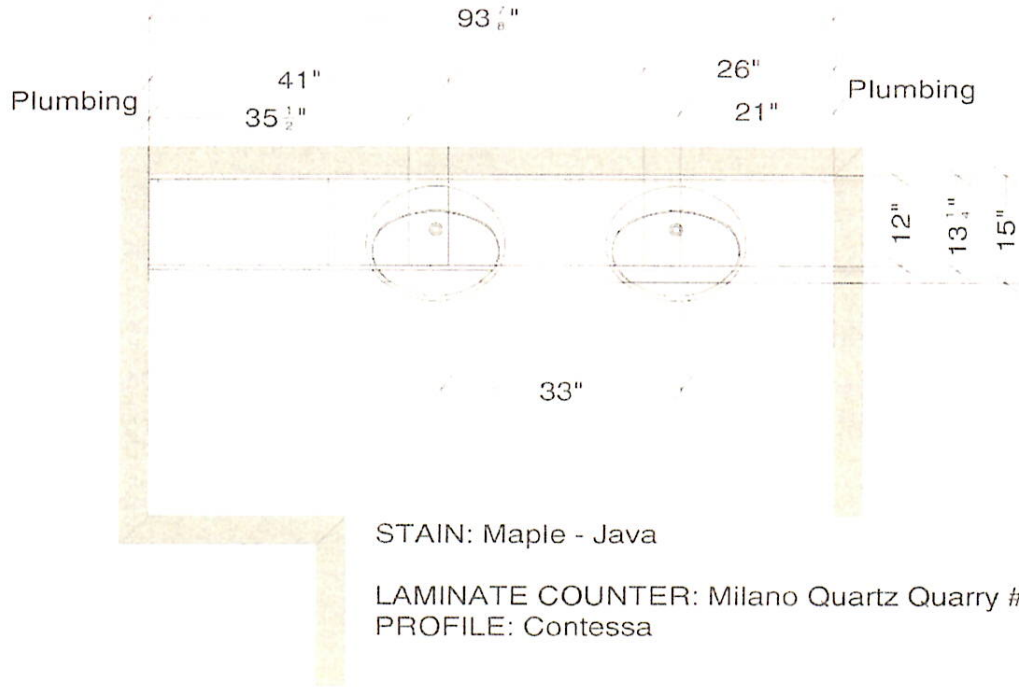

FITNESS

#17

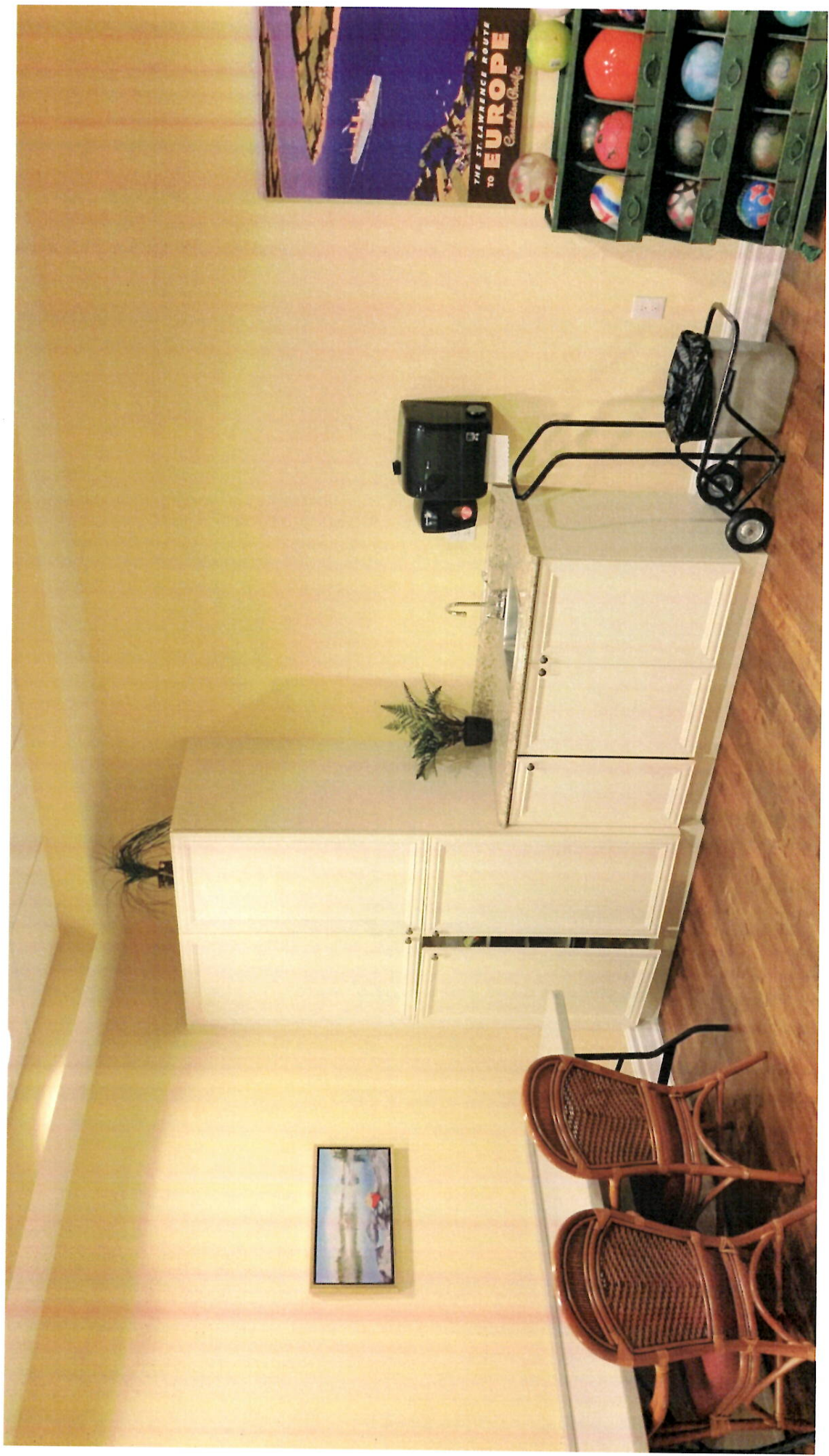

#

# FITNESS - B57

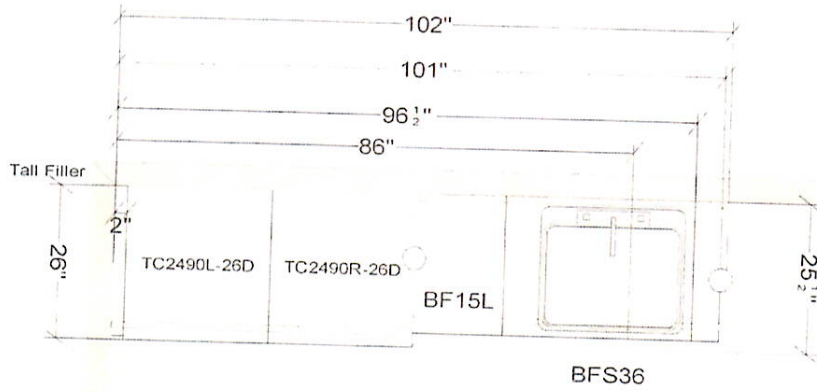

DOOR: EL00 Primo  
COLOUR: Antique White

LAMINATE COUNTER: Milano Quartz Quarry # 4726-52  
PROFILE: Contessa

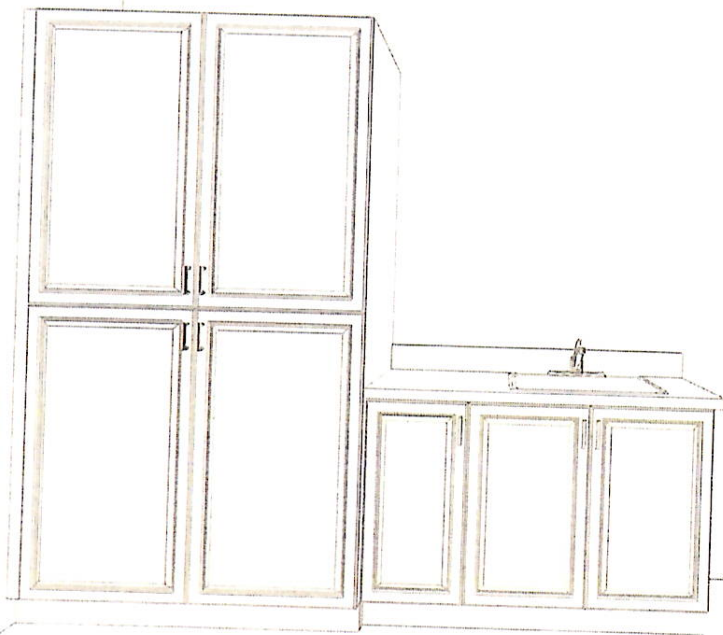

201  
#

# OFFICE KITCHENETTE - 262

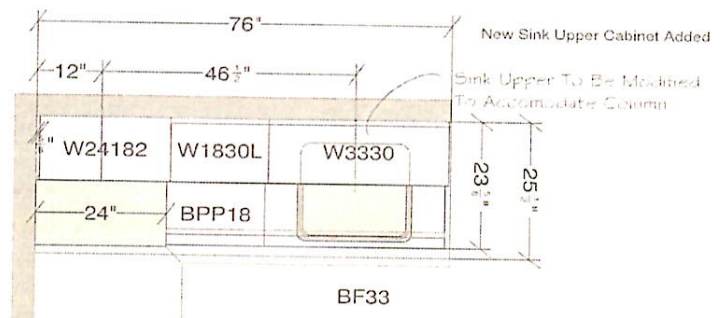

DOOR: EL00, Primo  
COLOUR: Antique White

LAMINATE COUNTER: Milano Quartz Quarry # 4726-52  
PROFILE: Contessa

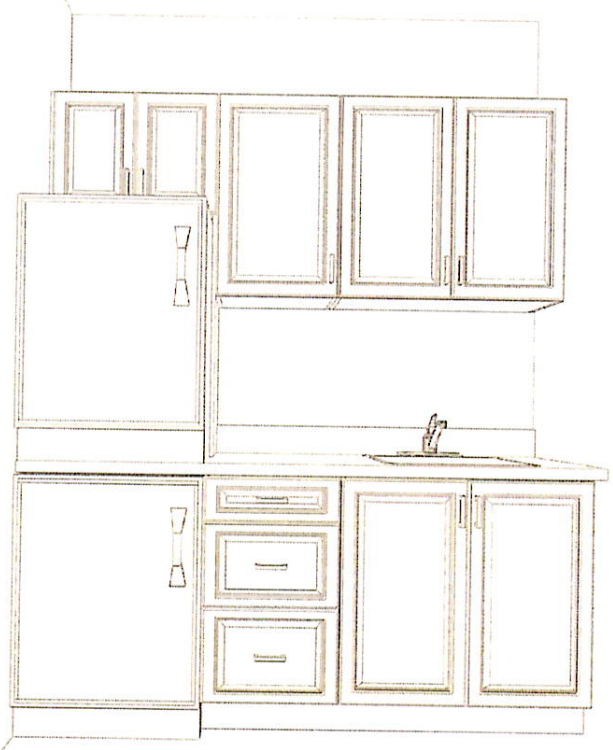

Milwaukee on Posts

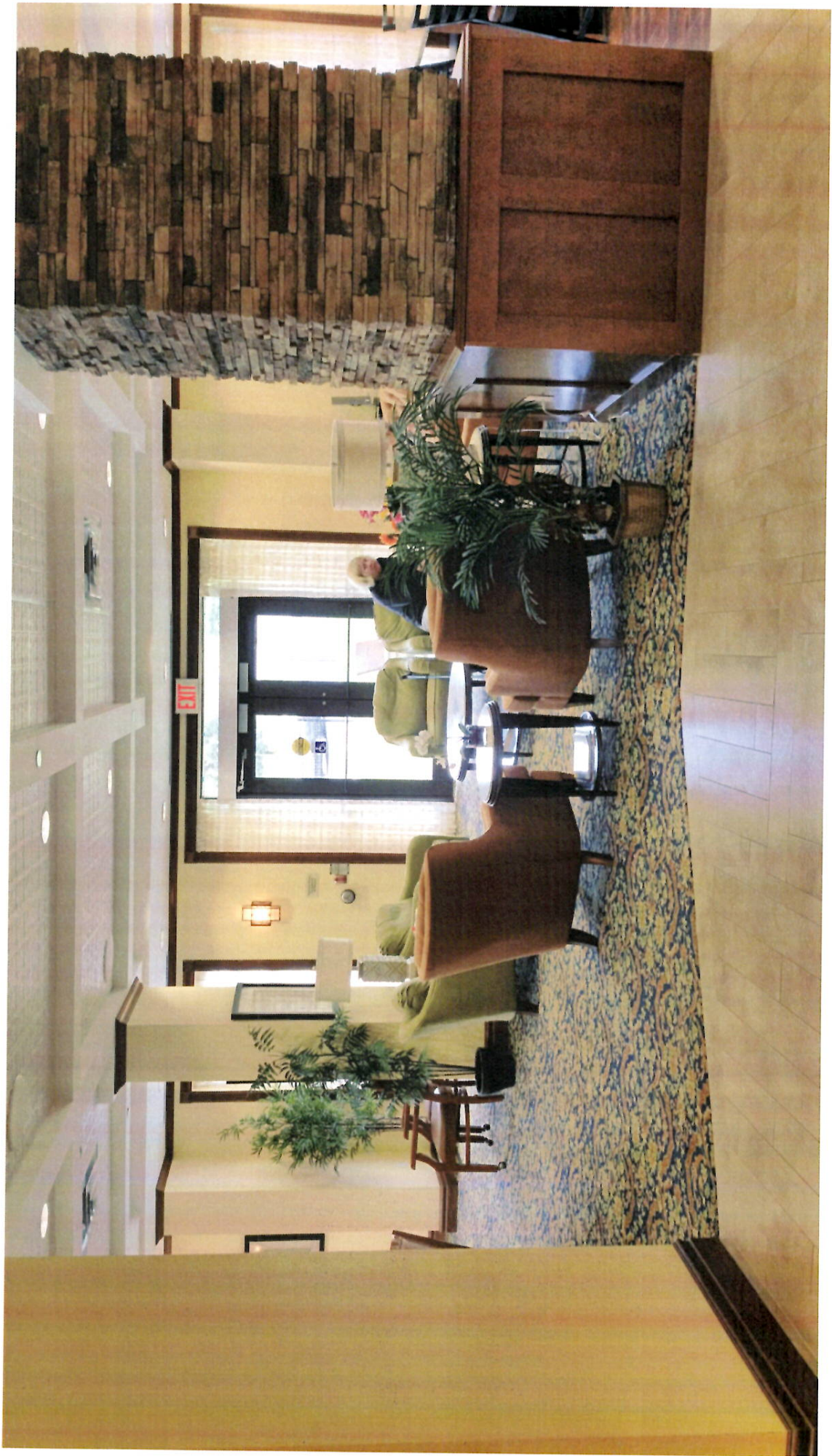

# LOBBY POST - 166

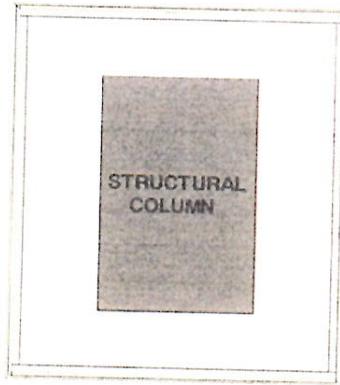

Millwork Cladding Around Planter Box

MATERIAL: Maple  
STAIN: BRANDY

