

ST MARY CATHOLIC SCHOOL MILLWORK SHOP DRAWING REVIEW

Tal-co Building Innovations Review by Farah Bano on April 18, 2019

1. Revise & resubmit Cover Page to include PM Contact Information:
Name: Farah Bano
Phone: 613-978-1007
- ✓ 2. Revise & re-submit Shop Drawing, Sheet 8 of 12, Storage Rm Elevation #1. Cabinet should be two (2) shelves wide at 36" each width. Refer to attached contract drawings. *Attached @back.*

From: Michael Marsolais [<mailto:michael.marsolais@cdsbeo.on.ca>]
Sent: April-18-19 9:37 AM
To: Farah Bano <fbano@tal-co.com>
Subject: FW: [EXTERNAL]FW: [EXTERNAL]SMCS - Millwork Shop Drawings

From: Matt Morris [<mailto:matt@morriseng.ca>]
Sent: April 16, 2019 4:18 PM
To: Michael Marsolais <michael.marsolais@cdsbeo.on.ca>
Subject: [EXTERNAL]FW: [EXTERNAL]SMCS - Millwork Shop Drawings

SUBMITTAL / SHOP DRAWING REVIEW	
<p>This submittal/shop drawing review is for general conformance with drawings and specifications only. Contractor is completely responsible for all dimensions, details, quantities, supply, installation and construction. This review does not in any way relieve the Contractor of responsibility for compliance with the Contract Documents.</p>	
Client:	Catholic District School Board of Eastern Ontario
Project:	St. Mary Catholic School Carleton Place, Ontario
Submittal:	Millwork
Notes:	<i>- Shelving Unit 1 (#20,21,22,23) is too long, as there is a window in that wall – please verify when site measuring</i>
<p>MORRIS ENGINEERING LTD. 68 William Street, Suite 200, Brockville, Ontario (613)499-2077</p>	



Millwork Shop Drawing

St. Mary Catholic School

Job # 522

4 Hawthorne Ave., Carleton Place, ON.

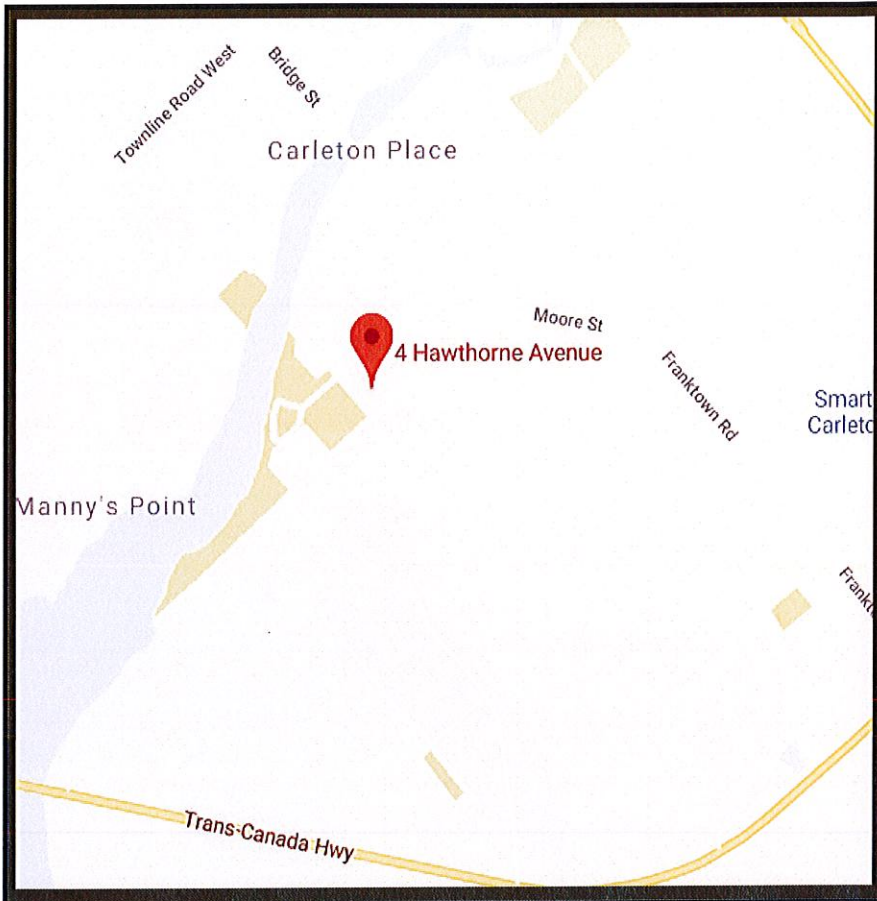

Perth Cabinet Project Manager

Ian Tyler

ian@perthcabinet.ca

Site Measured

Date: _____

Revised Date: March 29, 2019

Drafter

Jay Armstrong

jay@perthcabinet.ca

Date Drafted: March 29, 2019

**TAL-CO Building
Innovations Ltd.**

PM Contact Info.

Name: ~~Brian McMullen~~ FARAH BANO

Phone: 613-978-1007

~~b.mcmullen@frecon.ca~~

Site Contact Info.

Name: TBD ?

Phone: TBD. ?

Directions:

Turn right onto HWY # 7 / Turn left onto Mississippi Rd.
Turn right onto Lake Ave. W. / Turn left onto Hawthorne Ave.

Destination will be on the left

4 Hawthorne Ave.
Carleton Place, ON

Phone: (613)-267-6494



Saftey Directions To Hospital

St. Mary Catholic School

Job # 522

4 Hawthorne Ave., Carleton Place, ON.

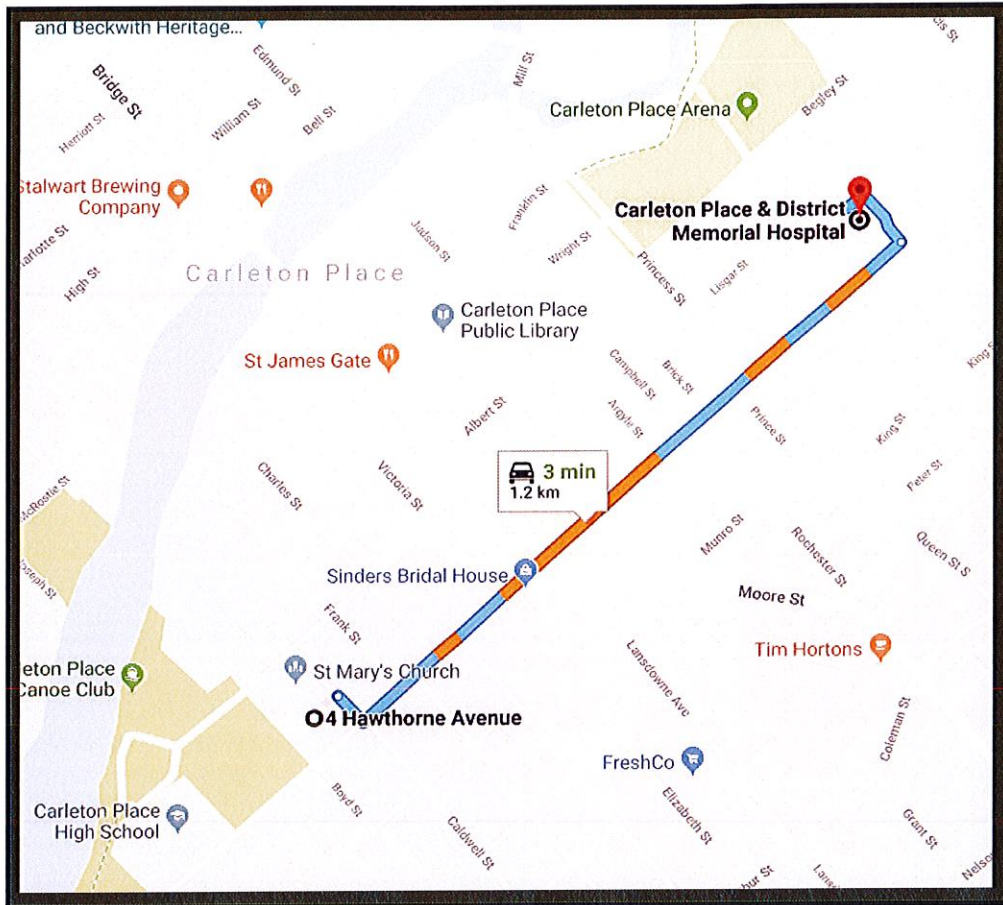

Directions:

Head southeast on Hawthorne Ave toward Lake Ave. W. / Turn left onto Lake Ave. W.
Turn left

Destination will be on the left

Carleton Place & District Memorial Hospital
211 Lake Ave E, Carleton Place, ON.

(7 Minutes To Destination)

Phone: (613)-267-6494



Laminate Colour Chart

St. Mary Catholic School

Job # 522

4 Hawthorne Ave., Carlton Place, ON.

PL-1		MW-1			
Formica:		Birch:	UV Veneer		
Counter:	Cabinet:				
?					

Date: March 29, 2019

Phone: (613)-267-6494



Architectural Floor Plan

St. Mary Catholic School

Job # 522

4 Hawthorne Ave., Carlton Place, ON.

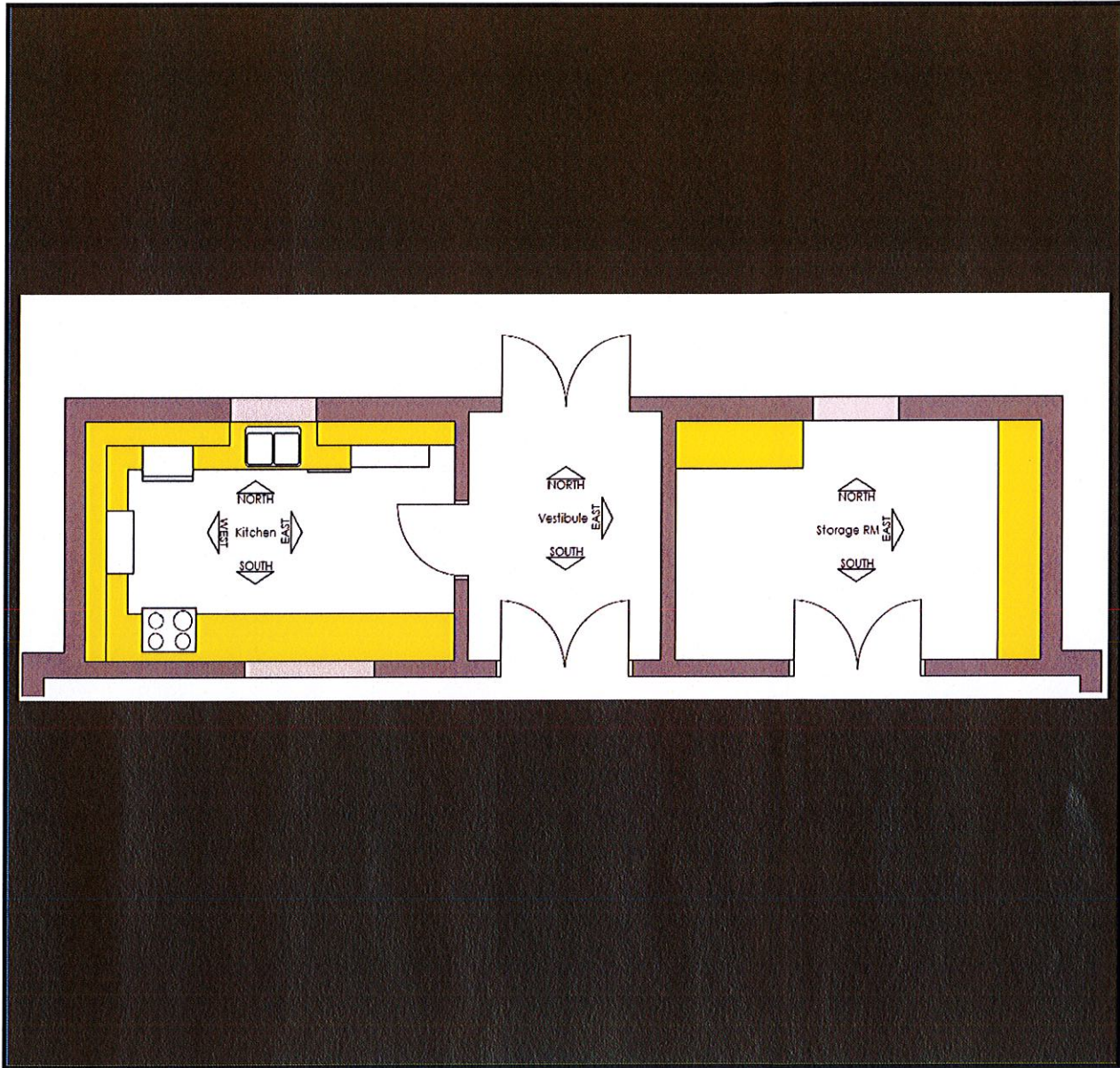

Phone: (613)-267-6494



Postform Counter Cut Sheet

St. Mary Catholic School

Job # 522

4 Hawthorne Ave., Carlton Place, ON.



INNOVATION

COMPTOIR AVEC DOSSERET / COUNTERTOP WITH BACKSPASH

DIMENSION

CUISINE / KITCHEN				VANITE / VANITY				NON-STANDARD			
A	B	A	B	A	B	A	B	A	B		
p.inch	mm	p.inch	mm	p.inch	mm	p.inch	mm	p.inch	mm		
24 1/2	622.3	3 1/2	88.9	22"	558.8	3 1/2	88.9	20	508.0		
25"	635.0	3 1/2	88.9	22 1/2	571.5	3 1/2	88.9	21	533.4		
25 1/2	647.7	3	76.2	23	584.2	3 1/2	88.9	24	609.6		

C	Epaisseur / Thickness	5/8"	15.9 mm
D	Epaisseur hors bar / Overall thickness	1 1/4"	31.7 mm

COMPTOIR LUNCH / BAR TOP

PLUS LARGE / WIDER				NON-STANDARD	
p.inch	mm	p.inch	mm	p.inch	mm
15	381.0			20	508.0
25 1/2	647.7	30 • 32	762.0 • 812.8	21	533.4
26 1/4	670.5	36 • 39 • 42	914.4 • 990.6 • 1,066.8	22	558.8
				24	609.6

- NOTES:**
- Profondeur minimale avec dos: 16", compteur lunch: 7 1/2"
 - Profondeur maximale avec dos: 30", compteur lunch: 5 1/2"
 - Minimal depth with backsplash: 16 1/2", bar top: 7 1/2"
 - Maximal depth with backsplash: 30", bar top: 5 1/2"

5/8"

COMPTOIR AVEC DOSSERET / COUNTERTOP WITH BACKSPASH

DIMENSION

CUISINE / KITCHEN				VANITE / VANITY			
A	B	A	B	A	B	A	B
p.inch	mm	p.inch	mm	p.inch	mm	p.inch	mm
24	609.6	3	76.2				
25 1/4"	641.4	3	76.2	22 1/2"	571.5	3	76.2

C	Epaisseur / Thickness	3/4"	19 mm
D	Epaisseur hors bar / Overall thickness	1 1/2"	38.1 mm

COMPTOIR LUNCH / BAR TOP

PLUS LARGE / WIDER			
p.inch	mm	p.inch	mm
26	660.4	36 • 39 • 42	914.4 • 990.6 • 1,066.8

- NOTES:**
- Profondeur minimale avec dos: 17", compteur lunch: 7 1/2"
 - Profondeur maximale avec dos: 30", compteur lunch: 5 1/2"
 - Minimal depth with backsplash: 17", bar top: 7 1/2"
 - Maximal depth with backsplash: 30", bar top: 5 1/2"

3/4"

Phone: (613)-267-6494

All Cabinetry Is Manufactured Using CNC Technology / Blind Dadoed Glued & Nailed

INTERIOR CABINETS - 19mm UV birch veneer plywood w/ 6mm solid birch edge finished clear.
EXPOSED CABINETS - 19mm UV birch veneer plywood w/ 6mm solid birch edge finished clear.
CABINET DOORS - 19mm birch veneer Particle core w/ 6mm solid birch edge finished clear.
COUNTERTOPS - Postform plastic laminate (PL-1) 16mm thick particle core.
TOE KICKS - 19mm plywood w/ applied rubber base by others on all exposed surfaces.

STANDARD CABINET PULLS - Perth Cabinet Standard "D".
HINGES - Blum clip top Hinge 120° w/ horizontal cam mounting plate.
DRAWER SLIDES - Accuride full extension ball bearing slide, series 3832
SHELF SUPPORTS - Recessed KV pilasters and Clips.

Notice: Rectangles In Section Views Represent Hinges & Hinge Quantities.
Clear silencer bumpers on all cabinet doors and drawers.

**-All Wall-to-Wall and Floor-to-Ceiling Measurements
Need To Be Site Verified.
-All Mechanical, Electrical & Water Locations
Will Be Verified At Time Of Site Visit.**



Project Specifications

PO# 522	Job:St. Mary Catholic School
Drafted By: Jay	
Date: 03/29/19	
Sheet 1 of 12	

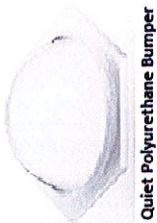

Quiet Polyurethane Bumper

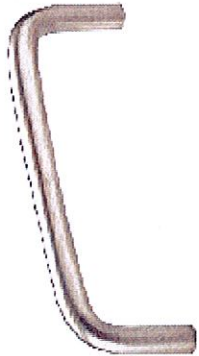

CBH 220 x89
Richelieu-Standard "D" Steel Pull



Horizontal Cam
Mounting Plate
Zinc Euro Screw
Pozi Drive

Blum 120 deg Self Closing Hinge

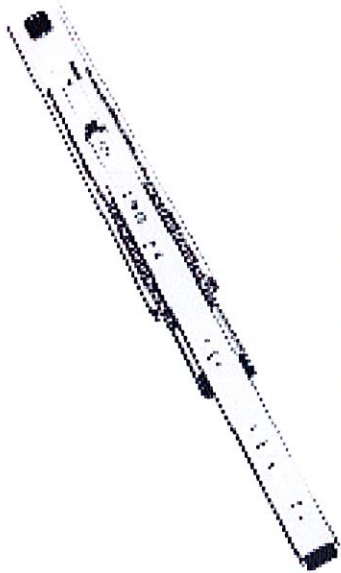

Accride 3832
Full Extension Ball Bearing Slide



Recessed Shelf
Plaster & Clips



<input type="checkbox"/>	<input type="checkbox"/>	<input type="checkbox"/>	<input type="checkbox"/>	<input type="checkbox"/>	<input type="checkbox"/>
--------------------------	--------------------------	--------------------------	--------------------------	--------------------------	--------------------------

Almond Clear White Clear White Nurflex Silicone
Dap Alex Plus



Catalogue Cuts

PO# 522	Job: St. Mary Catholic School
Drafted By: Jay	
Date: 03/29/19	

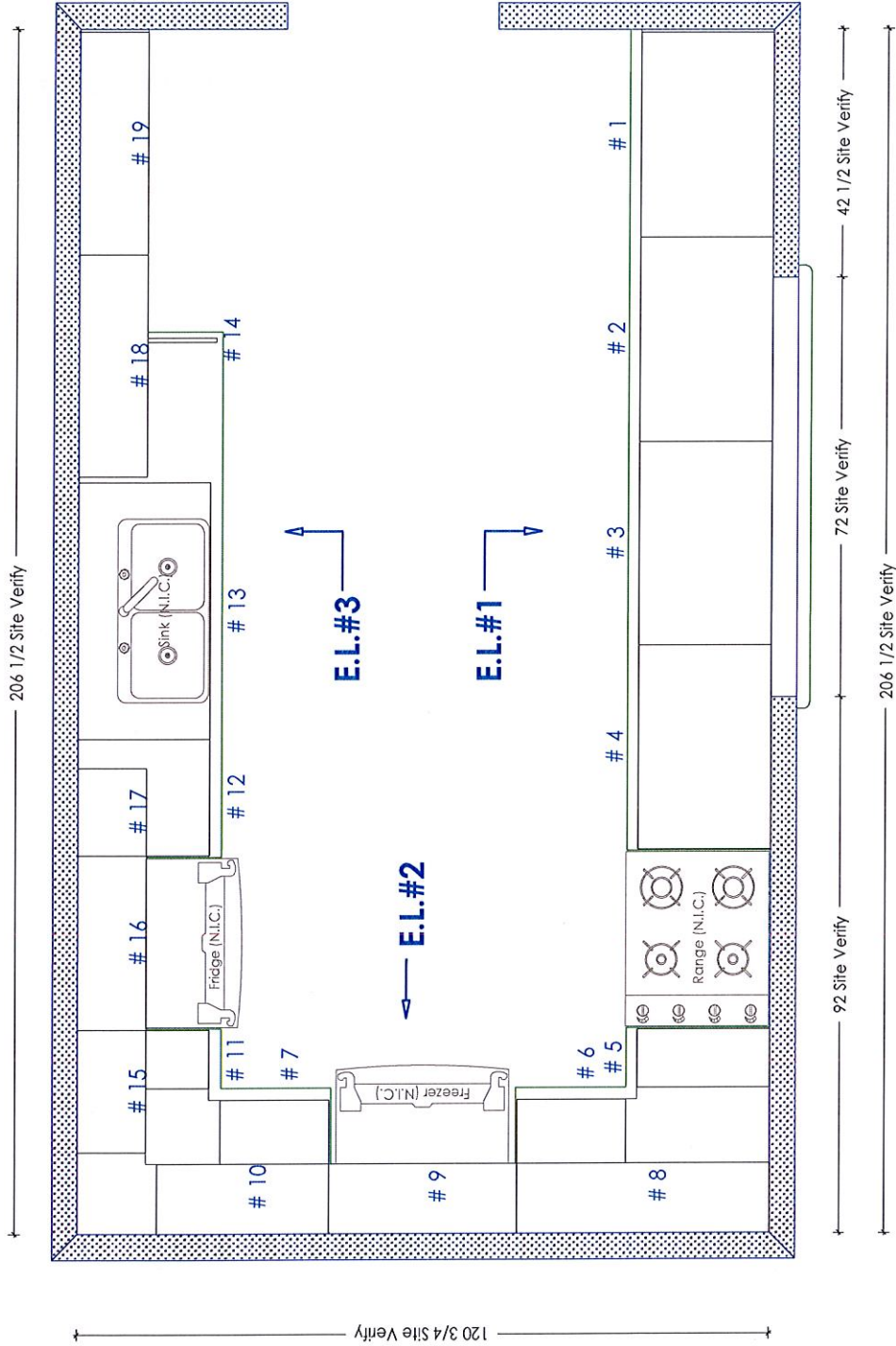

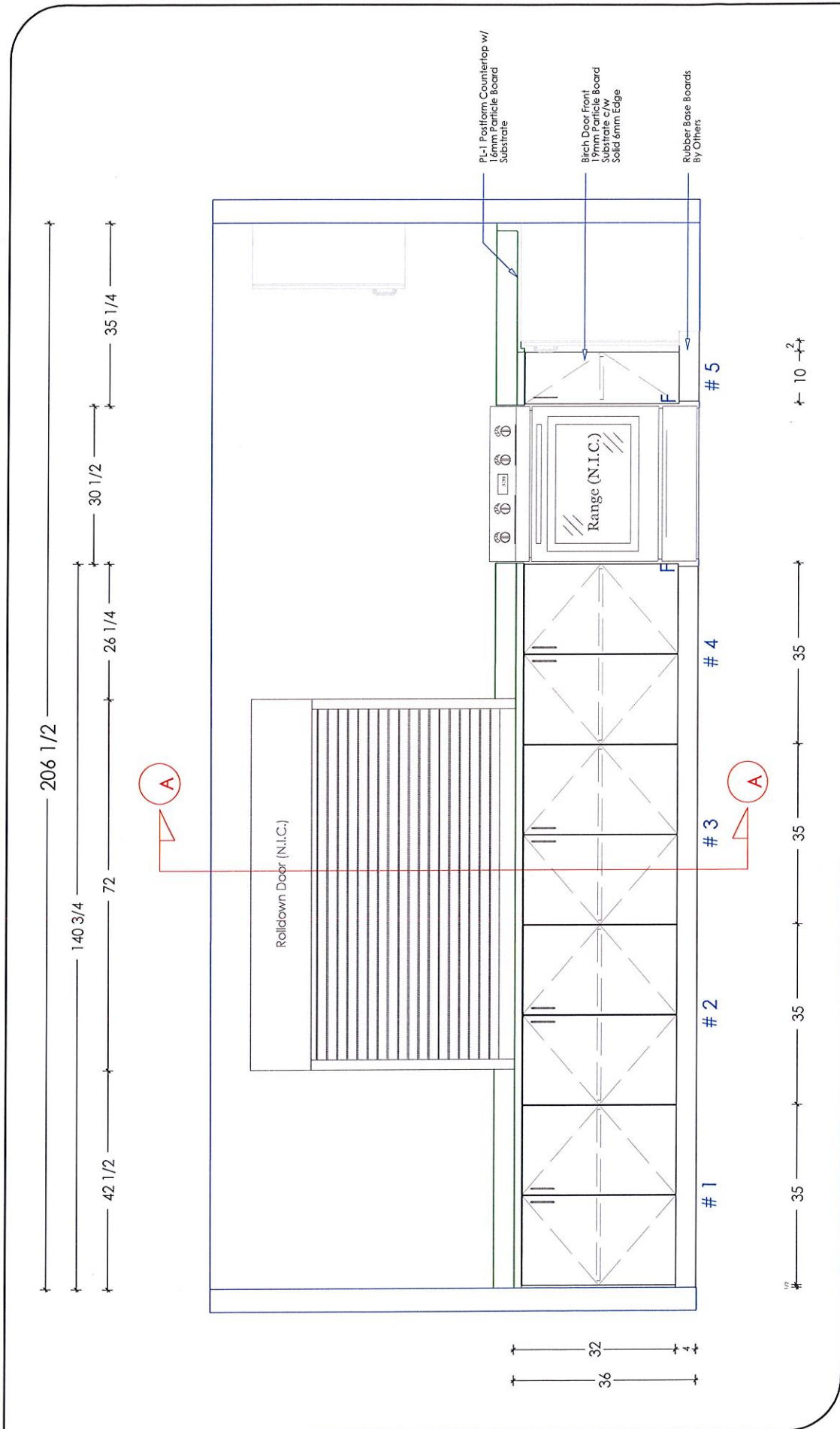

Kitchen Floor Plan

PO# 522	Job:St. Mary Catholic School
Drafted By: Jay	
Date: 03/29/19	
Sheet 3 of 12	



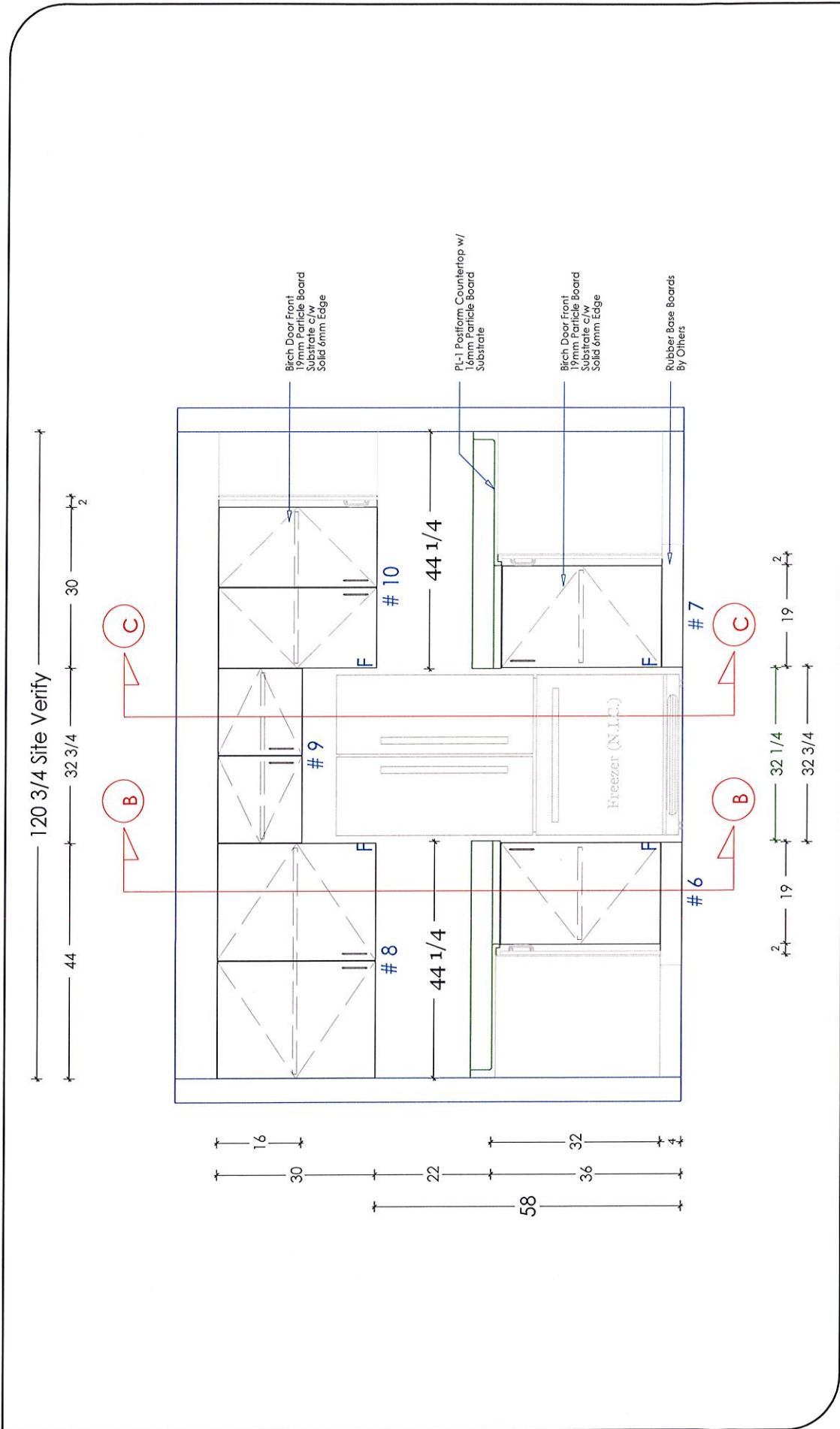

Perth Cabinet Company
Kitchen Elevation #1
 PO# 522 Job: St. Mary Catholic School
 Drafted By: Jay
 Date: 03/29/19
 Sheet 4 of 12

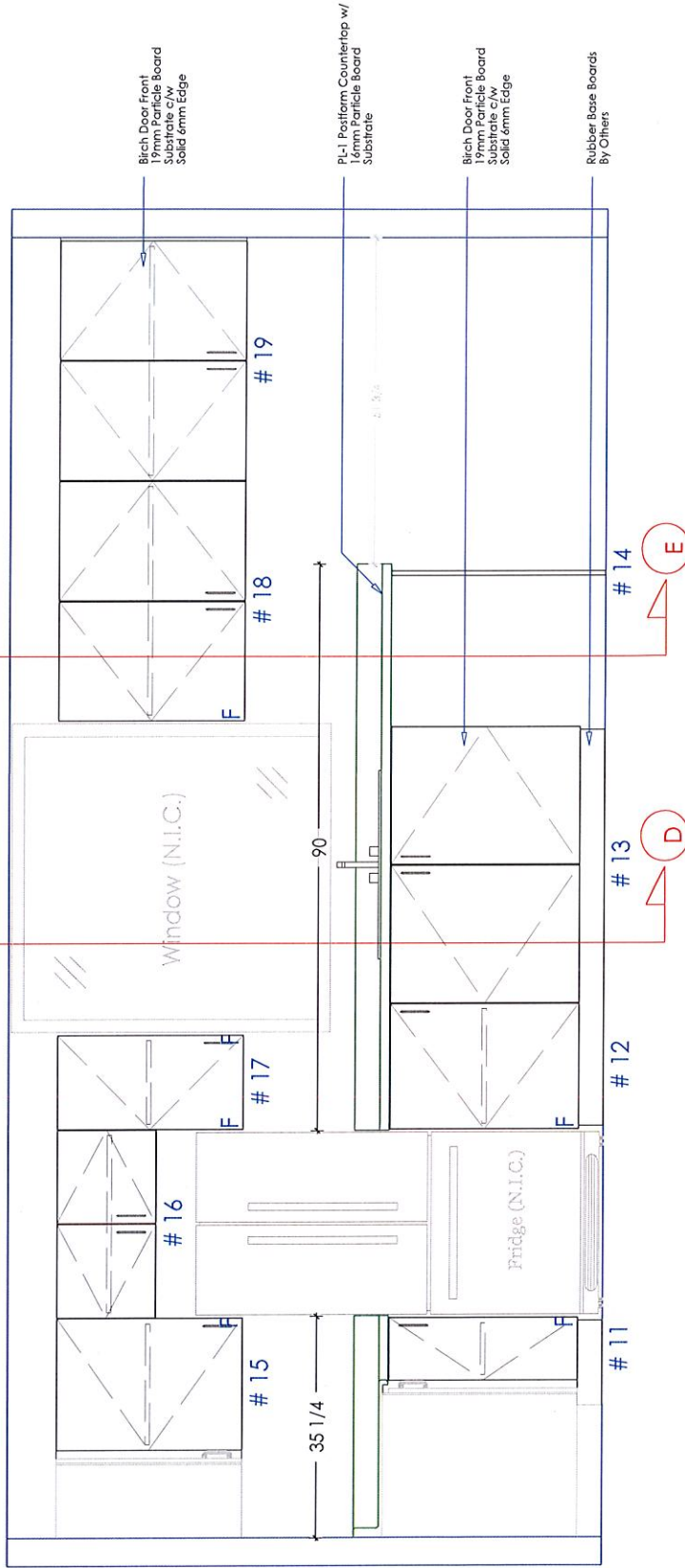
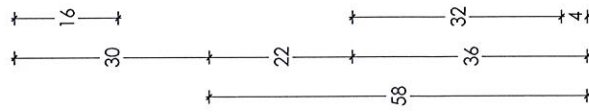

Perth Cabinet Company
Kitchen Elevation #2
 PO# 522 Job: St. Mary Catholic School
 Drafted By: Jay
 Date: 03/29/19
 Sheet 5 of 12

206 1/2 Site Verify



Birch Door Front
19mm Particle Board
Substrate c/w
Solid 6mm Edge

PL-1 Posiform Countertop w/
19mm Particle Board
Substrate

Birch Door Front
19mm Particle Board
Substrate c/w
Solid 6mm Edge

Rubber Base Boards
By Others



Kitchen Elevation #3

PO# 522	Job: St. Mary Catholic School
Drafted By: Jay	
Date: 03/29/19	
Sheet 6 of 12	

120 1/2 Site Verify

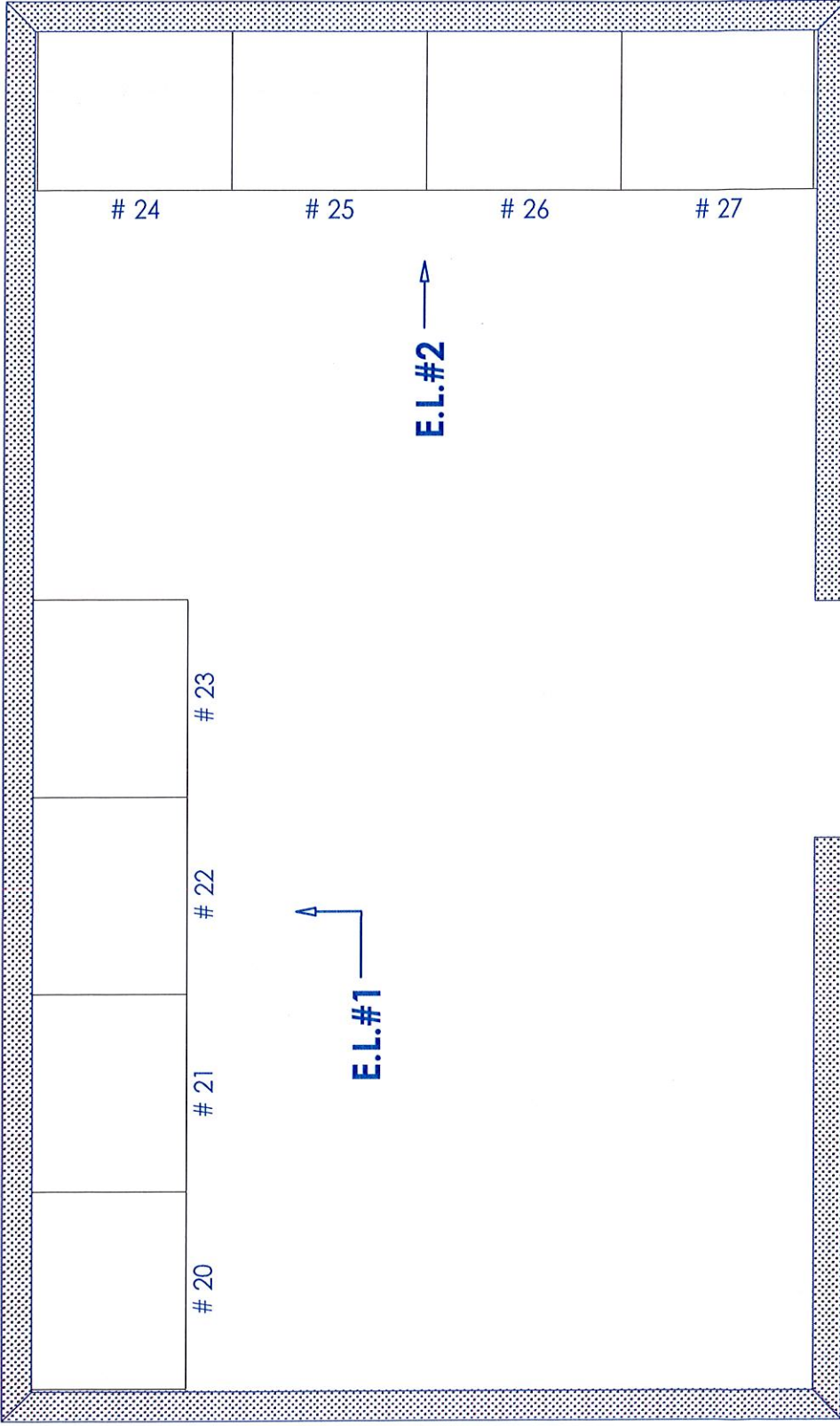

121 Site Verify



Storage Room Floor Plan

PO# 522	Job:St. Mary Catholic School
Drafted By: Jay	
Date: 03/29/19	
Sheet 7 of 12	

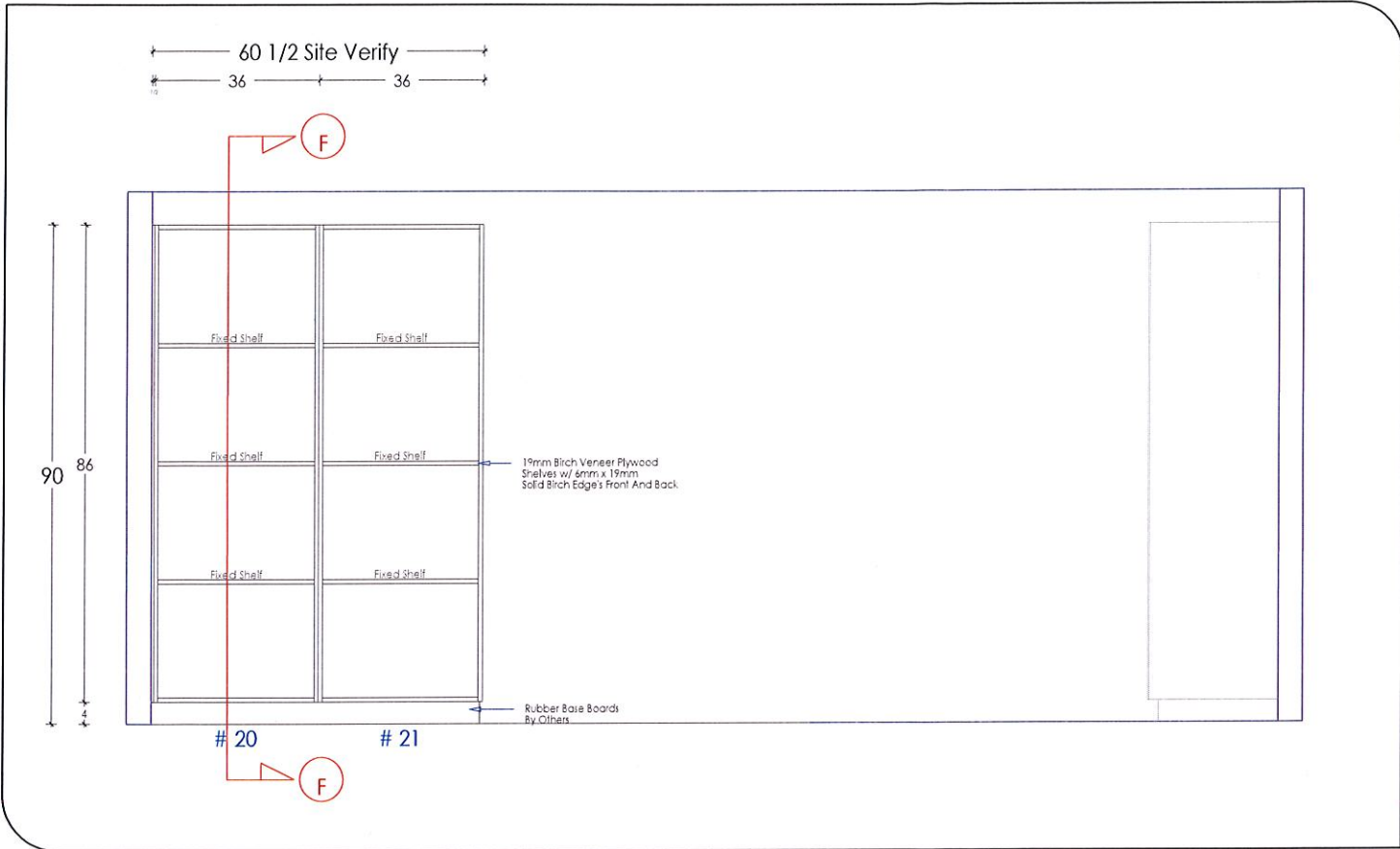

Storage Room E.L.#1

PO# 522	Job: St. Mary Catholic School
Drafted By: Jay	Sheet 8 of 12
Date: 04/23/19	

Revision Approved.

Faisal Zano

June 10th, 2019.



Storage Room E.L.#1

PO# 522 Job: St. Mary Catholic School
Drafted By: Jay
Date: 03/29/19

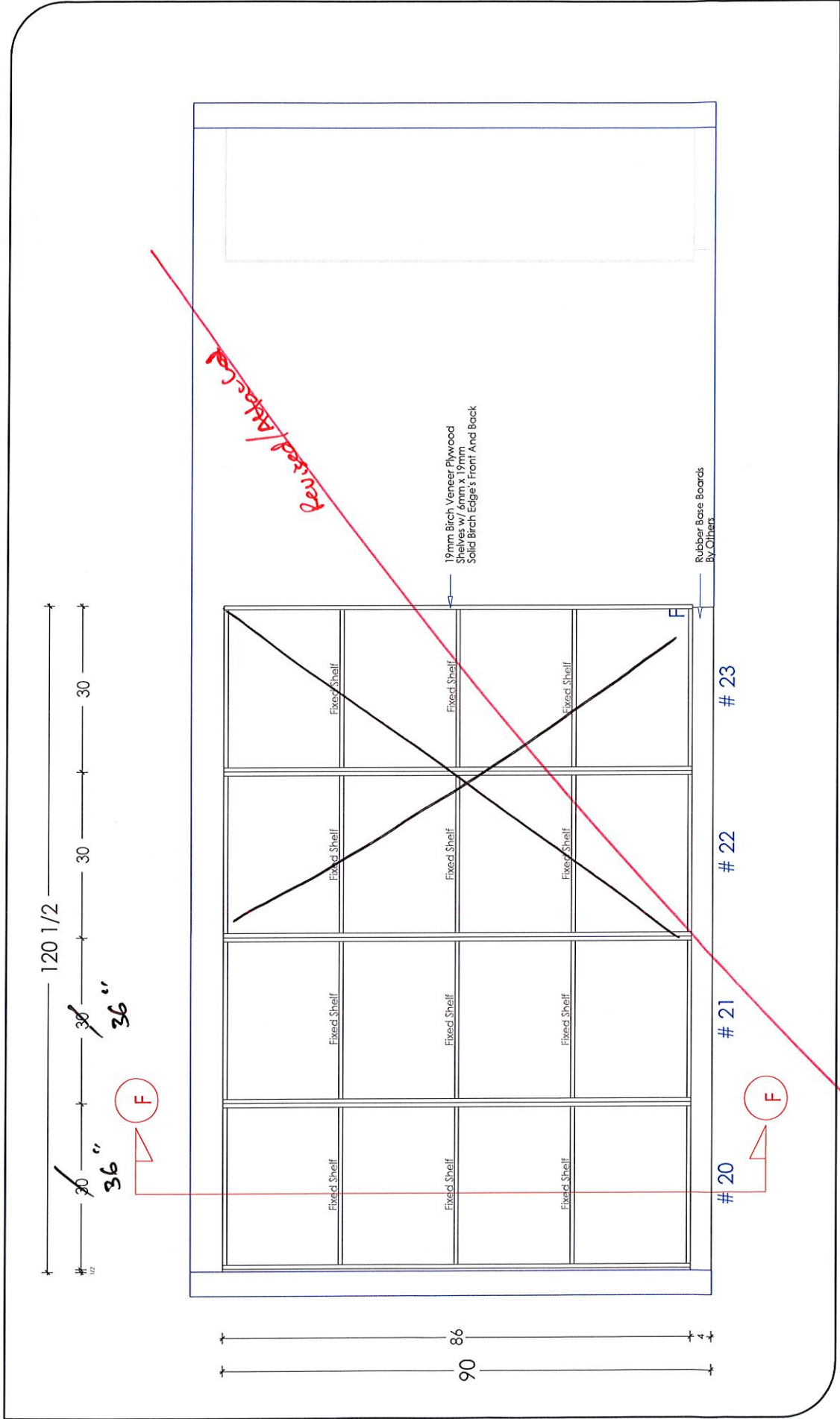

120 1/2
30 30 30 30
36" 36"

Fixed / Rubber Board

19mm Birch Veneer Plywood Shelves w/ 6mm x 19mm Solid Birch Edges Front And Back

Rubber Base Boards By: Olibest

20 # 21 # 22 # 23

90 86 4

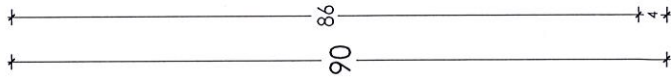
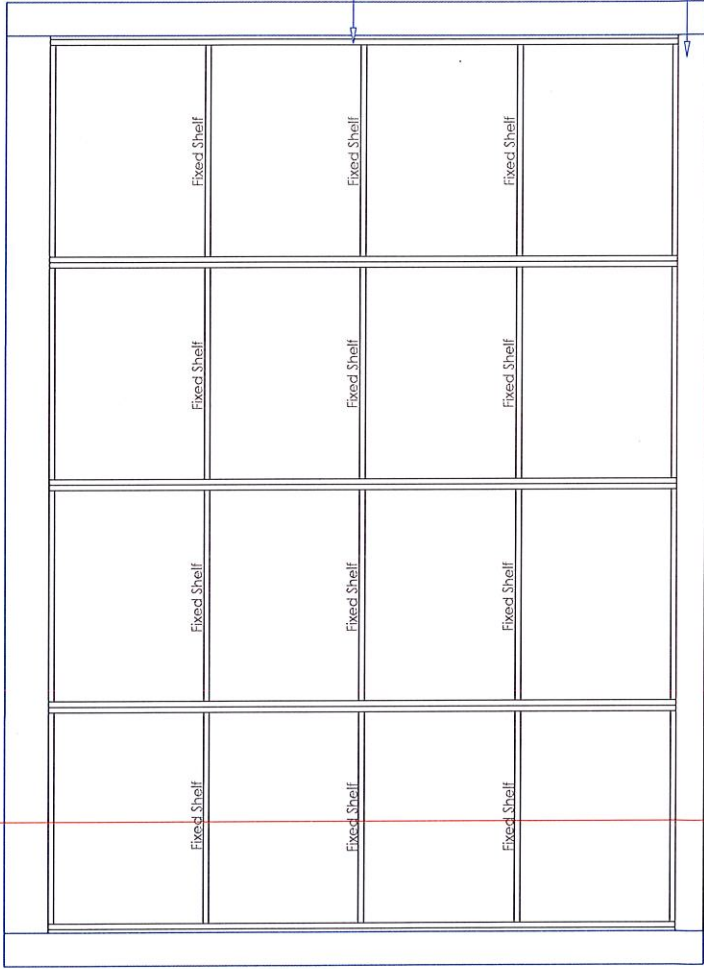
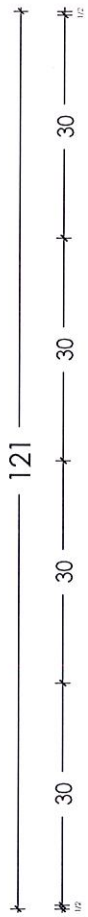

Storage Room E.L.#2

PO # 522	Job: St. Mary Catholic School
Drafted By: Jay	
Date: 03/29/19	
Sheet 9 of 12	

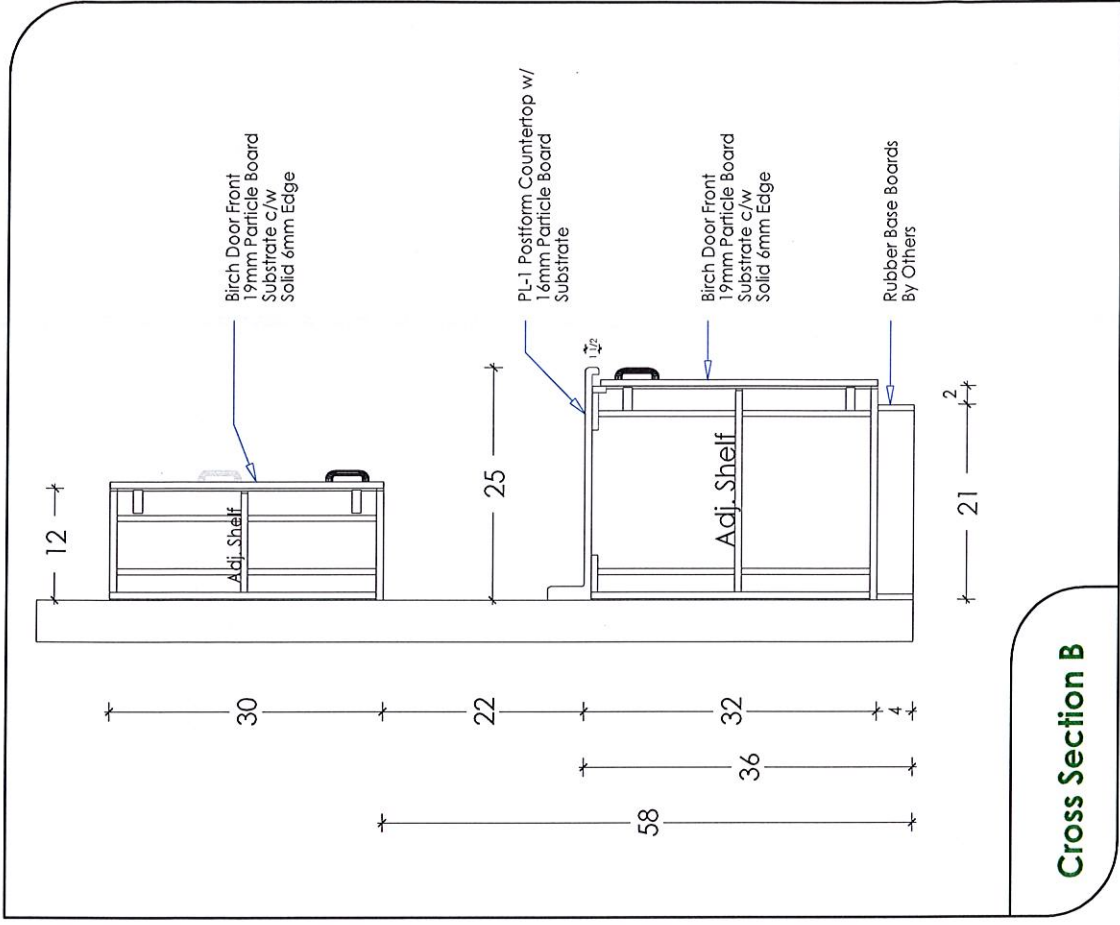
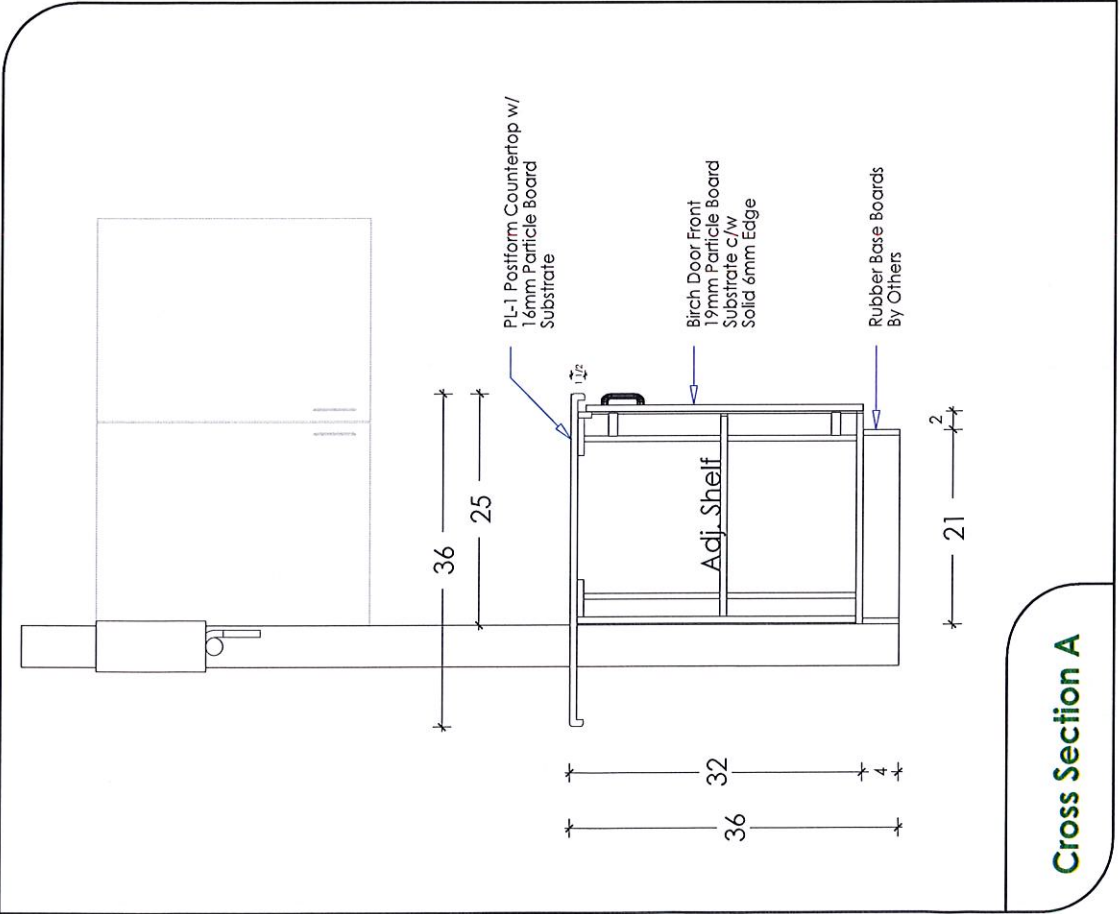

Perth Cabinet Company

Cross Section A & B

PO# 522	Job: St. Mary Catholic School
Drafted By: Jay	
Date: 03/29/19	

Sheet 10 of 12

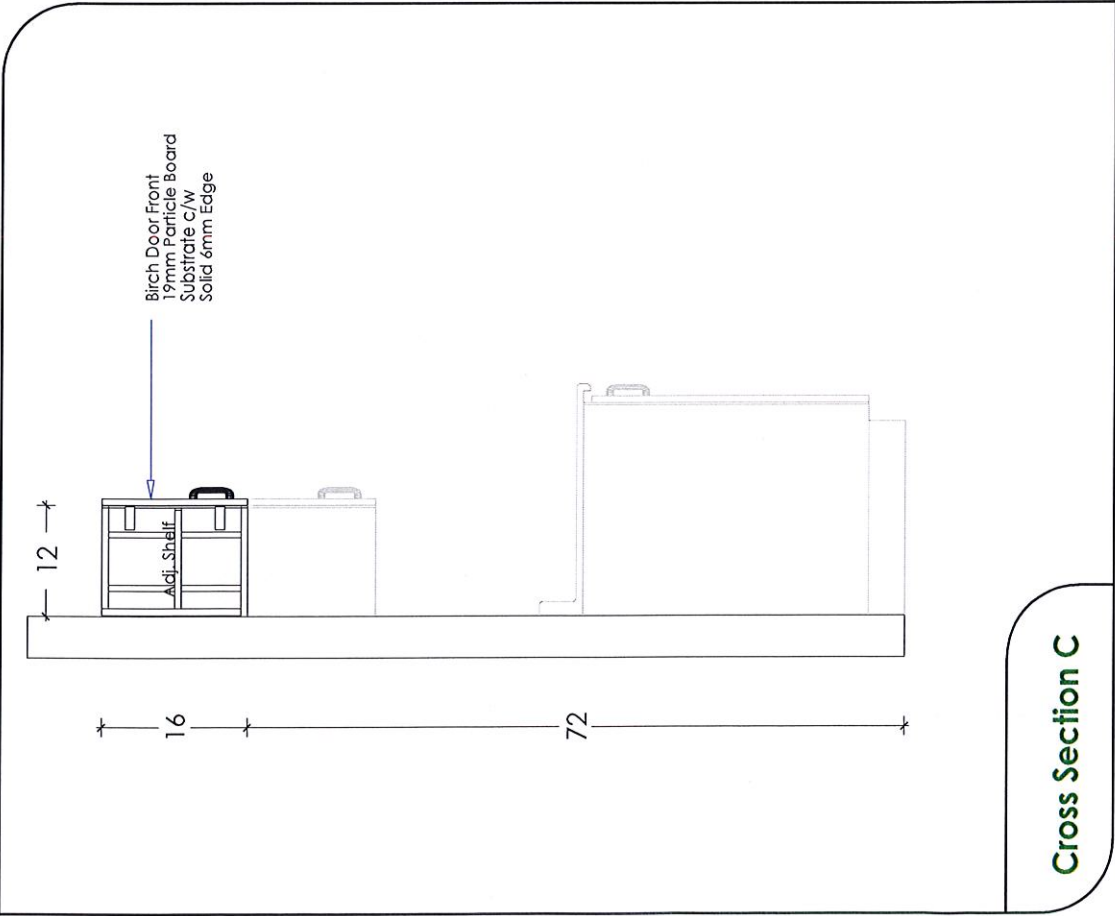

Cross Section C

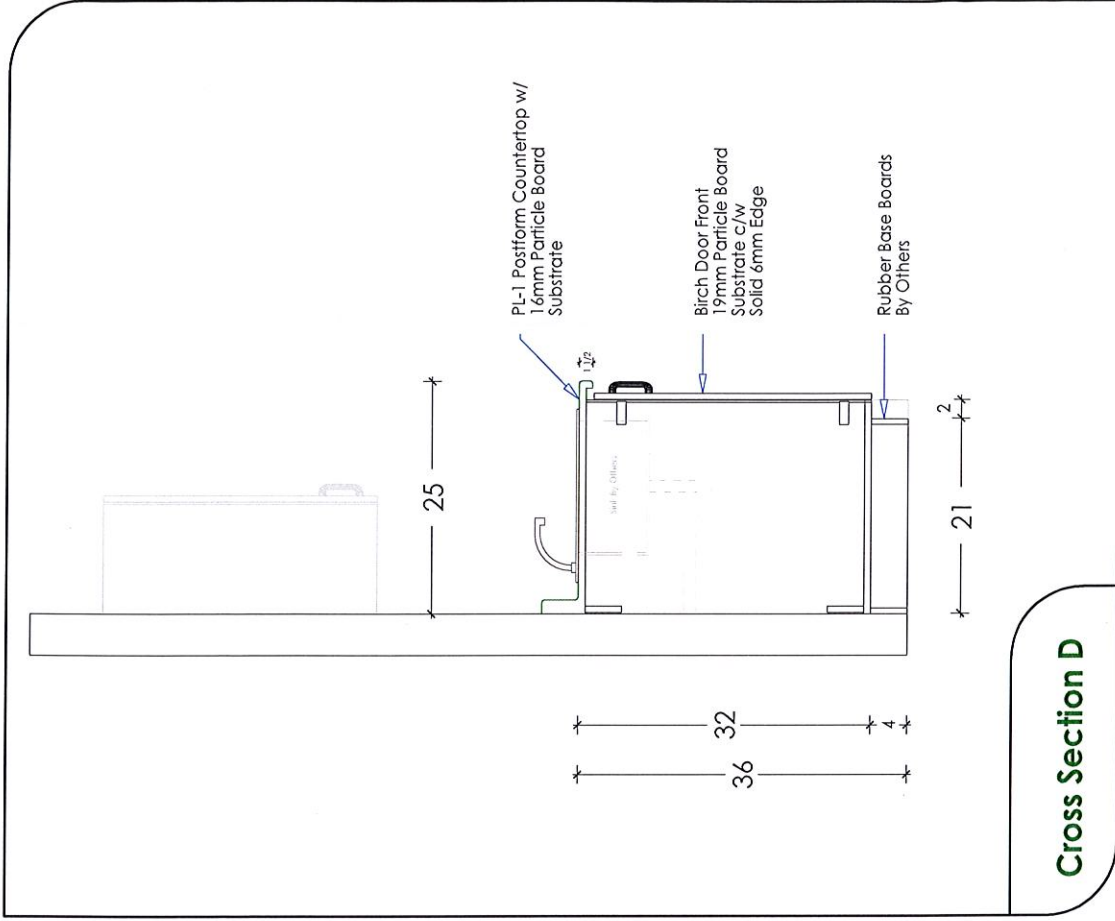

Cross Section D

Perth Cabinet Company

Cross Section C & D

PO# 522	Job: St. Mary Catholic School
Drafted By: Jay	
Date: 03/29/19	

Sheet 11 of 12

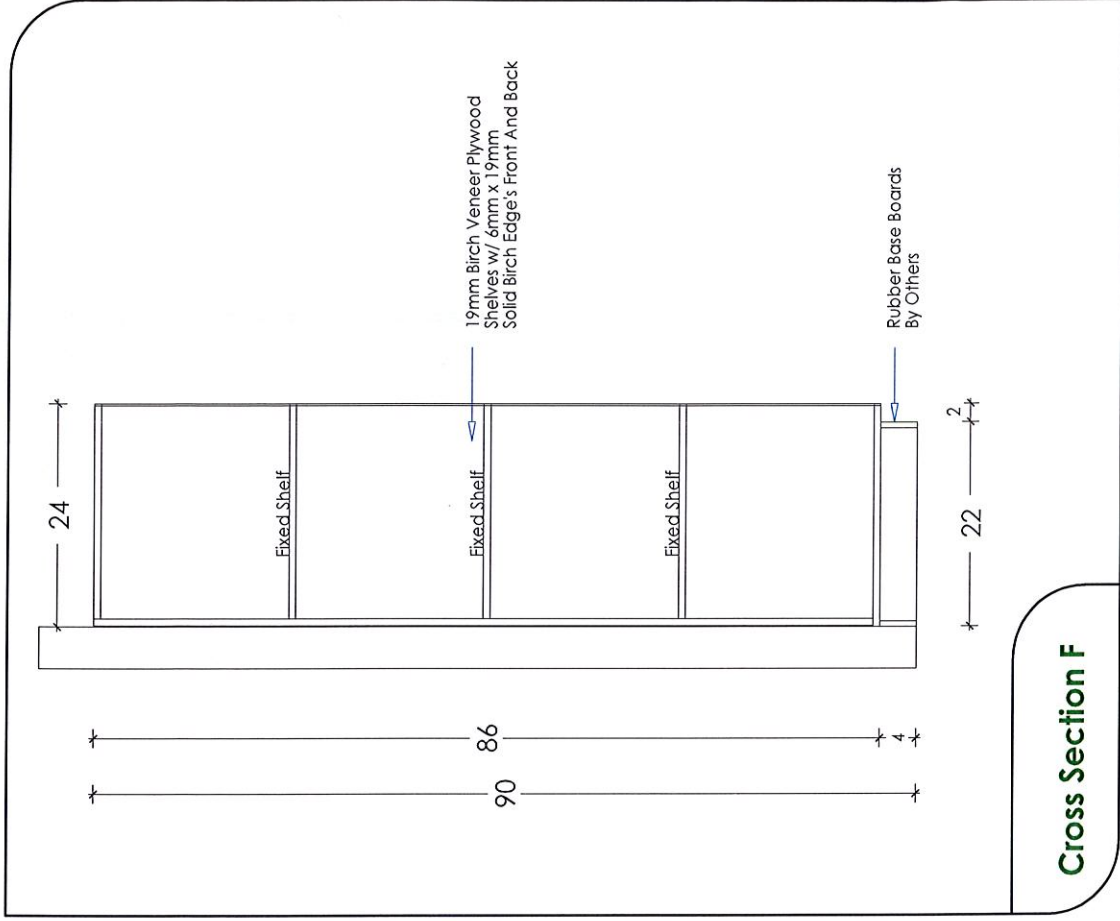
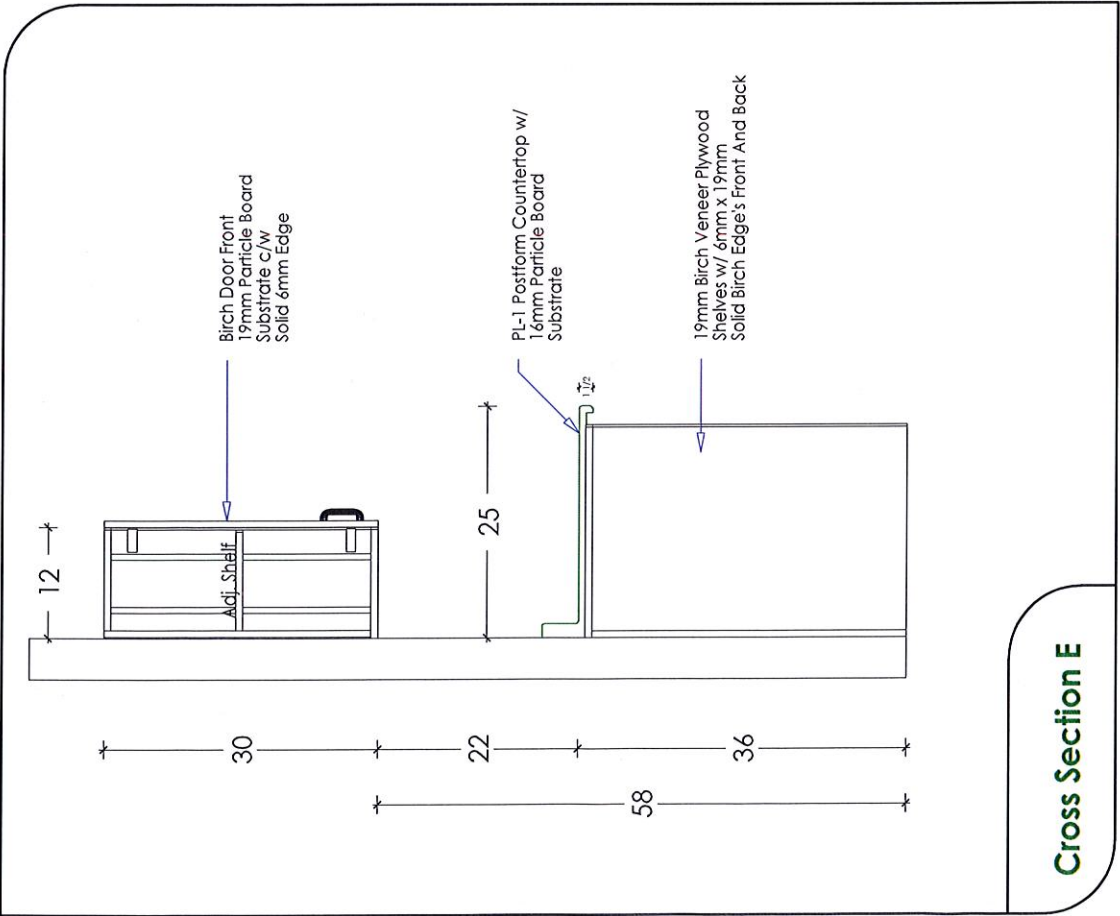

Perth Cabinet Company

Cross Section E & F

PO# 522	Job: St. Mary Catholic School
Drafted By: Jay	
Date: 03/29/19	

Sheet 12 of 12